



# User Manual

Hybrid Inverter

XD3~6KTL



深圳市英威腾光伏科技有限公司  
INVT Solar Technology (Shenzhen) Co., Ltd

## Contents

Chapter 1 Introduction .....	1
Chapter 2 Safety Precautions .....	2
2.1 Safety Symbols .....	2
2.2 Precautions for Operation .....	2
Chapter 3 Product Introduction .....	4
3.1 Intended User .....	4
3.2 Product Overview .....	4
3.3 Safety Instructions .....	5
3.4 Schematic Diagram of the Basic System .....	6
3.5 Product Features .....	7
Chapter 4 Installation .....	8
4.1 Unpacking .....	8
4.2 Preparations for Installation .....	9
4.3 Space Requirements .....	10
4.4 Dimension of Mounting Bracket .....	12
4.5 Product Dimension and Weight .....	12
4.6 Wall Mounting .....	13
4.7 Installation of Inverter .....	13
Chapter 5 Electrical Connection .....	15
5.1 Electrical Connection Overview .....	15
5.2 PV Wiring .....	17
5.3 AC Wiring .....	17
5.4 BAT Wiring .....	18
5.5. Communication Connection .....	19
5.6 CT Connection .....	21
5.7 Connection of Smart Meter .....	22
5.8 Connection of Grounding Wire .....	23
5.9 Parallel wiring .....	23
Chapter 6 Commissioning .....	25
6.1 Startup .....	25
6.2 Shutdown .....	25
Chapter 7 Parameter Settings .....	26
7.1 Menu Information .....	26

---

7.2 “Setting Info” Page .....	31
Chapter 8 System Debugging .....	54
8.1 LCD Screen and Keys .....	54
8.2 Working Mode .....	56
8.3 Setting Parameters in Solarman App .....	58
Chapter 9 System Maintenance .....	59
9.1 Regular Maintenance of Inverter .....	59
9.2 Powering Off the Inverter .....	60
9.3 Removing the Inverter .....	60
9.4 Scrapping the Inverter .....	60
Chapter 10 Troubleshooting .....	61
Chapter 11 Product Specifications .....	68

## **Chapter 1 Introduction**

This Manual describes the specification, installation, operations and maintenance of INVT hybrid inverter.





Please read this Manual carefully to understand the safety information, functions and features of the product before installing and using it. The information provided in this Manual is subject to update from time to time due to product improvements. The latest version and more product information are available on our official website.

## Chapter 2 Safety Precautions

Improper use may result in risk of electric shock or burns. This Manual provides important instructions for installation and maintenance of the product. Please read this Manual carefully before using the product, and keep it for future reference.

### 2.1 Safety Symbols

The following are the safety symbols used in this Manual to indicate potential safety risks and important safety instructions.

	<b>WARNING!</b> The warning symbol indicates important safety information that, if not followed properly, could result in serious personal injury or even death.
	<b>RISK OF ELECTRIC SHOCK!</b> The electric shock hazard symbol indicates important safety information that, if not followed, could result in electric shock.
	<b>Safety Tips!</b> This symbol indicates important safety information that, if not followed, could result in serious personal injury or even death.
	<b>HIGH TEMPERATURE!</b> This symbol indicates safety information that, if not strictly followed, could result in burns.
	<b>WARNING!</b> When performing maintenance on the input and output of the inverter after disconnecting it, wait at least 5 minutes for the inverter to discharge any remaining electrical charge.

### 2.2 Precautions for Operation

The hybrid inverter in XD3~6KTL series has been designed and tested according to the applicable safety regulations. This ensures the personal safety of the user. However, as an electrical equipment, the inverter could cause electric shock or other injuries if not operated properly. Please operate the inverter in accordance with the following requirements:

1. The wiring, installation and commissioning work should be carried out by professionals.
2. Be sure to read this Manual before operating the product. We shall not be held liable for any failure or loss caused by improper operation.
3. Before starting the installation or maintenance work, please break the connections at the AC side, DC side

and battery side, and then wait at least 5 minutes before proceeding to avoid electric shock.

4. When the inverter is running, the temperature of the casing is high. Do not touch it to avoid getting burned.
5. All electrical installations must conform to local electrical standards. The inverter should be connected to the power grid by professionals with the permission of the local power provider.
6. During the installation process, insulated tools and personal protective equipments should be used to ensure personal safety. To touch the electronic components of the inverter, please wear anti-static gloves, anti-static wrist strap or anti-static clothing so as to protect the inverter against electrostatic discharge.
7. Please install the inverter at a position that is out of the reach of children.
8. Do not plug or remove the AC/DC terminal during normal operation of the inverter.
9. The actual DC input voltage should not exceed the maximum allowable DC input voltage of the inverter.
10. Select an appropriate battery that matches the system, and set the battery type correctly. If you select a battery that does not match the hybrid inverter, the system cannot run.
11. If the battery has been completely discharged, please strictly follow the User Manual of the battery to charge the battery.
12. For system maintenance service, please contact our local authorized service personnel or our after-sales personnel.
13. The hybrid inverter system should be connected to the power grid after getting permission.
14. Turn off the PV switch before installing a solar PV panel during the sunny daytime, or there could be a serious risk of electric shock.
15. Do not connect a PV string to more than one inverter, as this could cause damage to the inverters.
16. Do not connect a device that relies on continuous and stable power supply (such as a life-sustaining medical device), to the emergency load port.

## Chapter 3 Product Introduction

### 3.1 Intended User

The hybrid inverter in XD series should be installed only by trained professionals who are familiar with local regulations, standards and electrical systems and have a good knowledge of this product.

It is highly recommended that the installer read this Manual carefully, so as to learn about product installation, troubleshooting and communication networking.

### 3.2 Product Overview

The inverter in XD series is intended to store the energy generated in the PV system or public power grid into the battery, and also output energy to the power grid. In the case of electric power failure, the hybrid inverter can provide energy to the load as a backup power supply.

This Manual applies to the following hybrid inverter models:

XD3KTL\XD3K6TL\XD4KTL\XD4K6TL\XD5KTL\XD6KTL

Overview:

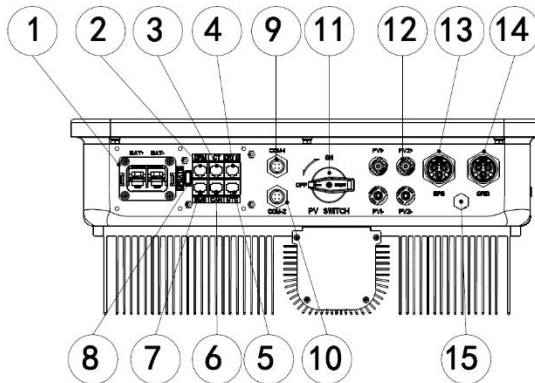

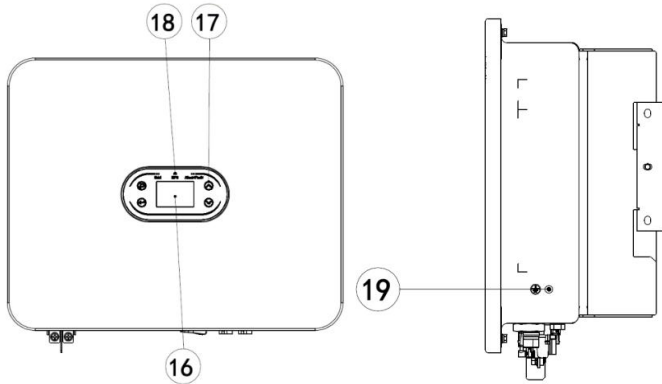

No.	Description	No.	Description
1	Battery terminal	2	RJ45 interface of DRMs (AS)
3	RJ45 interface of CT	4	Dry contact & NTC
5	CAN2 (parallel communication)	6	CAN1 (parallel communication)
7	BMS lithium battery communication	8	USB port (software upgrade)
9	COM-1 (RS485 / Wi-Fi / GPRS communication)	10	COM-2 (smart meter / RS485 communication)
11	PV input DC switch	12	PV input terminal
13	EPS output terminal	14	Grid terminal
15	Breather valve	16	LCD screen
17	Function keys	18	LED (indicator light)
19	GND (grounding point)		

### 3.3 Safety Instructions

1. Be sure to read this Manual before operating the product. We shall not be held liable for any failure or loss caused by improper operation.
2. Select an appropriate battery that matches the system, and set the battery type correctly. If you select a battery that does not match the hybrid inverter, the system cannot run.
3. If the battery has been completely discharged, please strictly follow the User Manual of the battery to charge the battery.
4. The wiring, installation and commissioning work should be carried out by professionals.
5. During the installation process, insulated tools and personal protective equipments should be used to ensure personal safety. To touch the electronic components of the inverter, please wear anti-static gloves, anti-static



wrist strap or anti-static clothing so as to protect the inverter against electrostatic discharge.

6. All electrical connections must comply with the safety regulations of the local power provider.
7. For system maintenance service, please contact our local authorized service personnel or our after-sales personnel.
8. The hybrid inverter system should be connected to the power grid after getting permission.
9. Turn off the PV switch before installing a solar PV panel during the sunny daytime, or there could be a serious risk of electric shock.
10. Do not connect a PV string to more than one inverter, as this could cause damage to the inverters.

### 3.4 Schematic Diagram of the Basic System

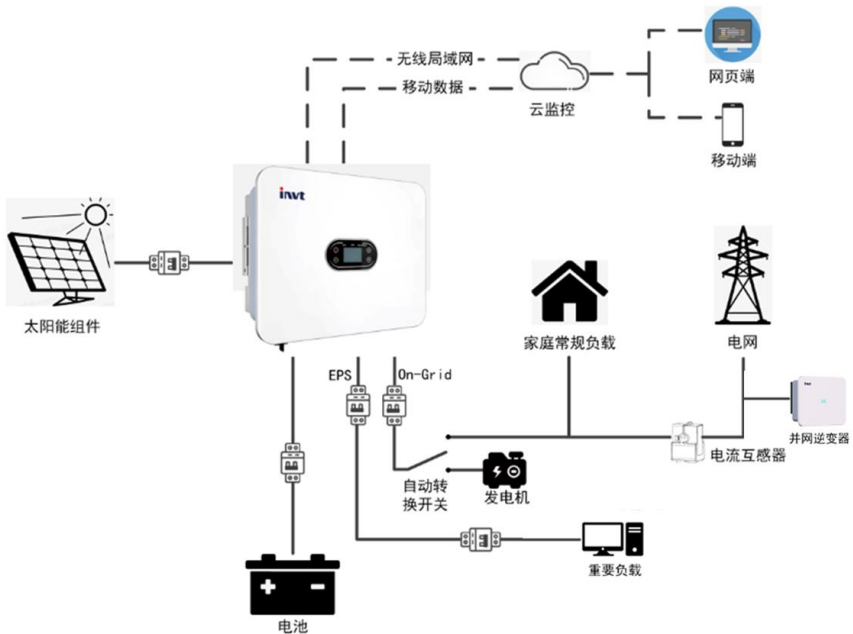

As shown in the above diagram, a complete hybrid inverter system in XD series consists mainly of the solar PV panels, hybrid inverter, battery and power grid.

Note: The battery is an integral part of the hybrid inverter system. Please keep the installation environment well-ventilated and take necessary measures to control the ambient temperature, so as to prevent the risk of explosion caused by high temperature.

Battery characteristics:

Ingress protection:  $\geq$ IP65; pollution degree: PD2; indoor temperature: 0°C~40°C; RH: 5%~85%

## 3.5 Product Features

1. Intelligent management system and multiple working modes, meeting different customer needs;
2. Allow you to set the priority of grid connection, battery type and other inverter information on the LCD screen;
3. Dual MPPT, high current input, compatible with large solar cell module of 210mm, flexible configuration;
4. All-in-one design, providing backup power and peak-shaving function;
5. Provide a battery safety management system, supporting remote upgrade of BMS system;
6. Support counter-current prevention;
7. Support over-temperature / over-current / short-circuit protection, ensuring safe, stable and reliable operation of the system;
8. Provide a variety of humanized communication module options (RS485, GPRS, Wi-Fi), supporting monitoring and remote operations through computer, mobile phone or Internet;
9. Support parallel communication of a maximum of six inverters;
10. Maximum conversion efficiency is as high as 97.5%;
11. IP66 rating, low weight, small size, easy installation.

## Chapter 4 Installation

### 4.1 Unpacking

The inverter has been fully tested and strictly inspected before delivery, but damage may still occur during transportation. Before unpacking, carefully check whether the product information on the purchase order and package label is consistent, and whether the product package is in good condition. If any damage of package is detected, contact the carrier or your dealer and provide photos of the damaged area, so as to receive the fastest and best service.

To keep the inverter idle for a long time, please place it in the original carton and protect it against moisture and dust.

After taking the inverter out of the carton, please check the following:

- (1) Whether the inverter remains in good condition;
- (2) Whether you have received the User Manual and all of the connection parts and mounting parts;
- (3) Whether the items you have received are free from damage and shortage;
- (4) Whether the product information indicated in the nameplate on the inverter is consistent with that indicated in the Purchase Order;
- (5) Check with the List of Standard Deliverables below.

Standard deliverables for hybrid inverter:

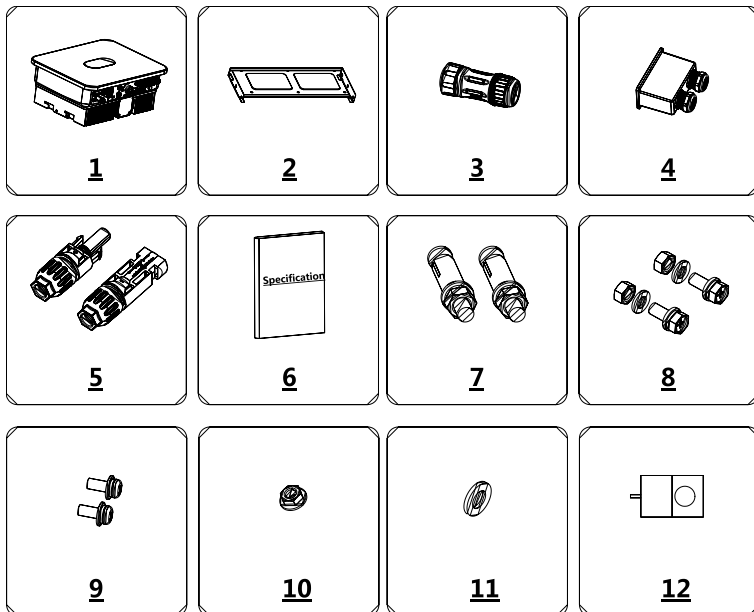

Fig. 4.1 Deliverables for Hybrid Inverter XD3-6KTL

Table 4-1 List of Deliverables for Hybrid Inverter

No.	Name	Quantity
1	Inverter	1
2	Mounting bracket	1
3	Quick-connect AC terminal and hexagon screwdriver	2
4	Wiring terminal	1
5	DC connectors (pair)	2
6	Accompanying documents (set)	1
7	M6×50 stainless-steel expansion bolt	6
8	M6 combination bolts	9
9	M4 combination screws	6
10	M6 nut	6
11	M6 flat washer	6
12	CT	1

Please check the above items carefully, and contact your dealer immediately if you have any questions.

## 4.2 Preparations for Installation

### 4.2.1 Installation Tools

Table 4-2 List of Installation Tools

No.	Installation Tool	Description
1	Marker	Mark mounting holes
2	Electric drill	Drill holes in the mounting bracket or wall
3	Hammer	Drive expansion bolts
4	Adjustable wrench	Fix the mounting bracket
5	Screwdriver	Fix the inverter and tighten the junction box
6	Slotted screwdriver or Phillips screwdriver	For AC wiring use
7	Megger	Measure the insulation performance and resistance to ground
8	Multimeter	To test circuits and measure AC/DC voltage
9	Electric soldering iron	To weld the communication cable
10	Wire crimper	To crimp the DC terminal
11	Hydraulic crimper	To crimp the AC O-terminal

### 4.2.2 Installation Conditions

- (1) The inverter can be installed in an indoor or outdoor environment.
- (2) During operation of the inverter, the housing and heat sinks will heat up. Do not install the inverter where it can be accessed easily.
- (3) Do not install the inverter in an area where flammable or explosive materials are stored.
- (4) Install the inverter in a well-ventilated environment, so as to facilitate heat radiation.
- (5) It is recommended to choose an installation position with shade, or build a sunshade.

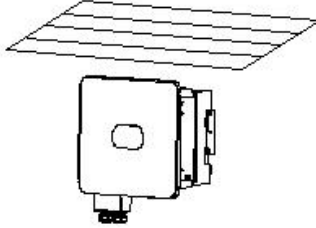

Fig. 4.2 Sunshade

- (6) Ambient temperature:  $-30^{\circ}\text{C}\sim 60^{\circ}\text{C}$ .
- (7) The installation position should be far away from electronic devices generating strong electromagnetic interference.
- (8) The installation position should be on a fixed and solid object surface, such as a wall or metal bracket.
- (9) The installation position must provide reliable grounding for the inverter, and the grounding metal conductor must be made of the same material as the reserved grounding metal conductor of the inverter.

### 4.3 Space Requirements

- (1) Install the inverter at such a height that allows the operator to observe the LED indicator lights of the inverter easily.

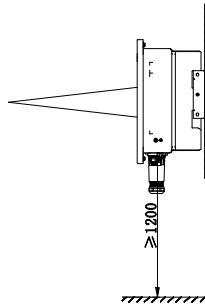

Fig. 4.3 Best Mounting Height

(2) Leave adequate space around the inverter to facilitate air circulation, and future handling of the inverter. See Fig. 4.4.

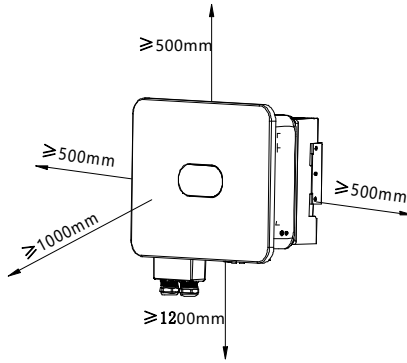

Fig. 4.4 Installation Spacing of Inverter

(3) To install more than one inverter, please keep a certain distance between the inverters and at the top/bottom of the inverters (see Fig. 4.5), so as to facilitate heat radiation.

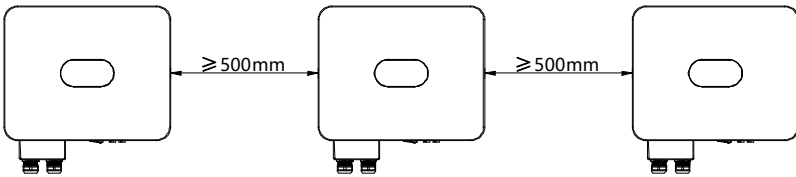

Fig. 4.5 Installation Dimension of Side-by-side Inverters

(4) The mounting surface should be upright (see Fig. 4.6). Install the inverter vertically or at a backward tilt of  $\leq 15^\circ$  so as to facilitate heat radiation. Forward tilt, horizontal installation, upside-down installation, backward tilt of  $>15^\circ$  and sideways tilt are not allowed.

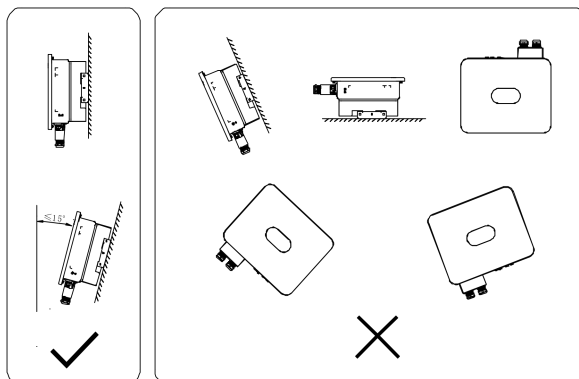

Fig. 4.6 Installation Location of Inverter

## 4.4 Dimension of Mounting Bracket

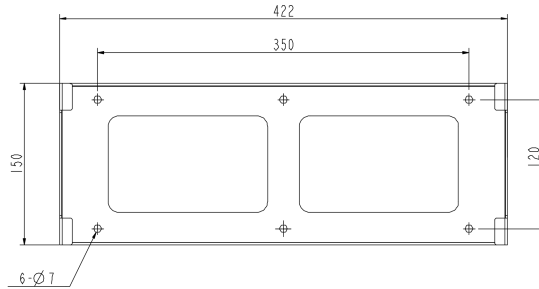

Fig. 4.7 Dimension of Mounting Bracket

## 4.5 Product Dimension and Weight

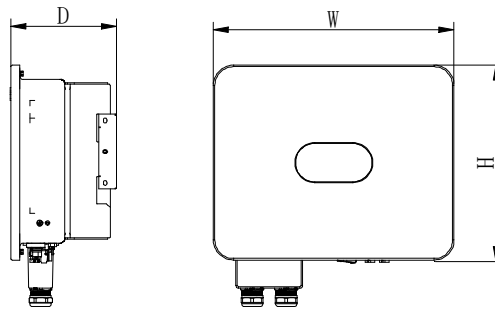

Fig. 4.8 Overall Dimension of Inverter

Dimension and net weight of hybrid inverter:

Model No.	Height (H) (mm)	Width (W) (mm)	Depth (D) (mm)	Net Weight (kg)
XD3~6KTL	390	481	200	22

Dimension and gross weight

Model	Height (mm)	Width (mm)	Depth (mm)	Weight (kg)	Package material
XD3~6KTL	485	575	320	26	Corrugated case

## 4.6 Wall Mounting

Step 1: The thickness of the wall for wall-mounted installation should be greater than or equal to 60mm. Using a marker and a spirit level, mark the points where you need to drill the holes.

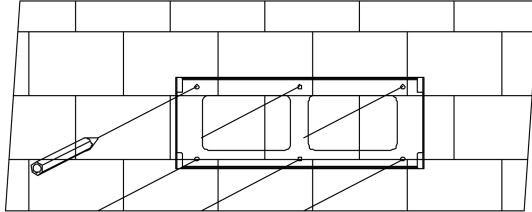

Step 2: Drill the holes (diameter:  $\phi 8$ ; depth:  $\geq 55$ mm) using a hammer drill, and then install M6 $\times$ 50 stainless-steel expansion bolts.

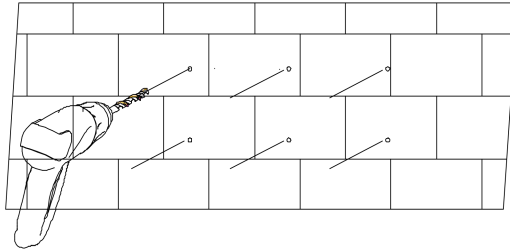

Step 3: Fix the mounting bracket. Clean the holes, drive expansion bolts into the holes using a rubber hammer. Tighten the nut to fix the tail of the bolt using a wrench, and then remove the nut, spring washer and flat washer. Fix the wall mount bracket to the wall with the nuts using a tightening torque of 5N•m.

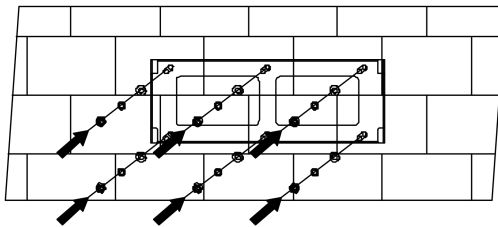

## 4.7 Installation of Inverter

Step 1: Take the inverter out of the carton.

Step 2: If the installation position is high, you can lift up the inverter to install it to the mounting bracket. Use a hoisting device to lift the inverter off the ground by 100mm, then pause and check the fastening of the lifting ring



and ropes. After confirming the inverter is fastened reliably, continue to lift it to its destination.

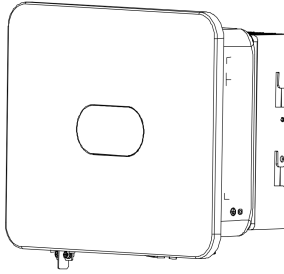

Step 3: Snap the bayonets of the inverter into the mounting bracket, and then press the inverter down to ensure that its radiator groove fits well with the mounting bracket.

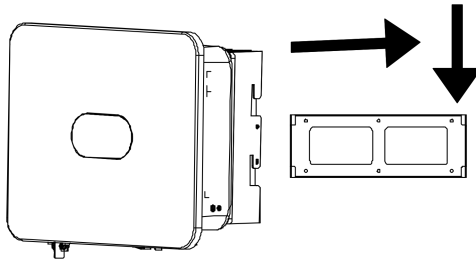

Step 4: Tighten M6×16 screws into the left and right holes of the radiator with a torque of 5 N•m so as to fix the inverter onto the mounting bracket.

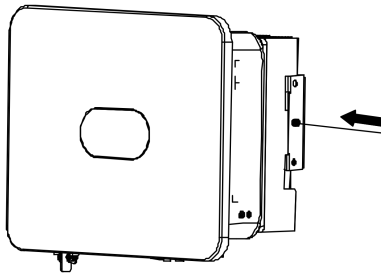

## Chapter 5 Electrical Connection

### 5.1 Electrical Connection Overview

This product supports the following power grid systems.

Note: If the power grid system contains a N wire, the neutral to ground voltage should be lower than 10V.

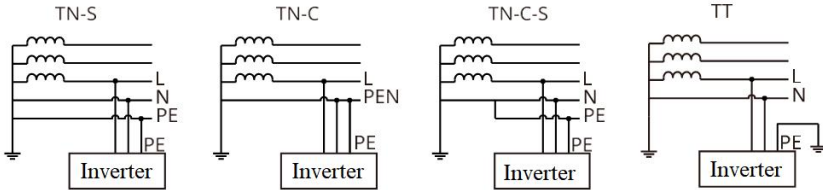

#### NOTE

- The connection modes between the N wire and PE wire and the GRID port and EPS port of the inverter may be vary in different regions. Please consult your local regulatory requirements.
- The GRID port and EPS AC port of the inverter have built-in relays. When the inverter works in off-grid state, the built-in GRID relay will be open; when the inverter works in on-grid state, the built-in GRID relay will be closed.
- When the inverter is powered on, the EPS AC port will be charged; if you need to perform maintenance of the EPS load, please power off the inverter first in order to avoid electric shock.

#### NOTE

The following wiring method is applicable for Australia, New Zealand and South Africa.

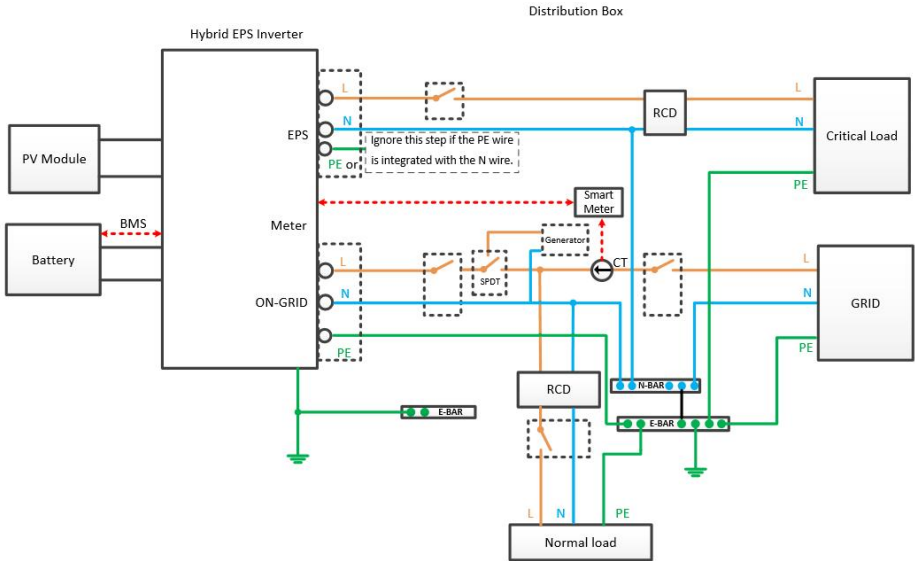

**NOTE**

- Make sure the BACK-UP grounding wire is properly connected and secured; otherwise, the BACK-UP function may fail in the case of power grid failure.
- The following wiring method is applicable for regions other than Australia, New Zealand and South Africa.

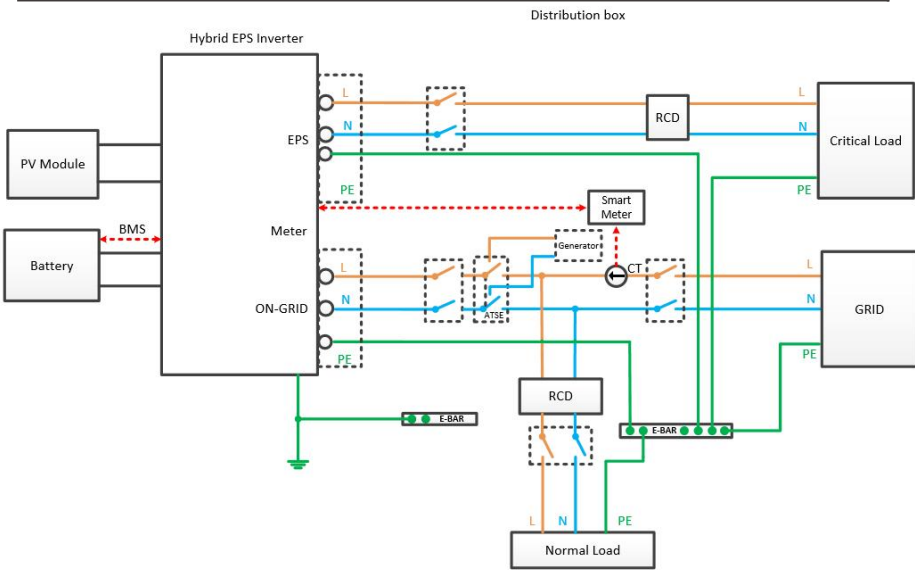

## 5.2 PV Wiring

MC4 connectors are provided at DC input side of the hybrid inverter. Below are the connection steps.

1. Turn off the DC switch.

2. Connect the positive terminal and negative terminal of the PV module respectively to the PV+ port and PV- port of the hybrid inverter. Make sure the actual input voltage and current fall within the allowable range.

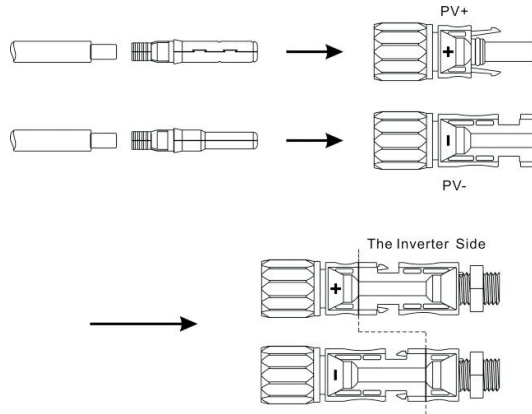

- Maximum allowable PV input voltage: 600V (please consider changes in the voltage at the minimum temperature).

- Maximum allowable PV input current: 16A.

Note: It is recommended to use a specialized PV cable  $\geq 4\text{mm}^2$  (11AWG).

## 5.3 AC Wiring

The AC output side is located at the bottom right of the hybrid inverter, containing an EPS port on the left and a GRID port on the right (see Chapter 3 Product Introduction for detailed information).

Step 1: Unscrew the AC terminal, and then use an appropriate tool to remove it as shown below.

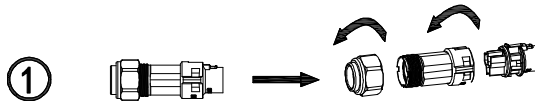

Step 2: Pass the cable through the rubber nut, sealing ring and threaded sleeve in turn. Connect the cable to the corresponding terminal based on the polarity mark, and then tighten the threaded sleeve onto the AC terminal as shown below:

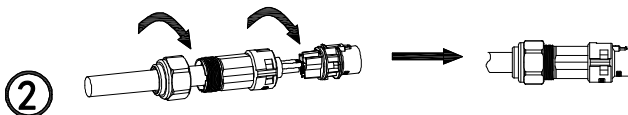

Step 3: Connect the prepared AC terminal to the EPS port or GRID port of the hybrid inverter as shown below.

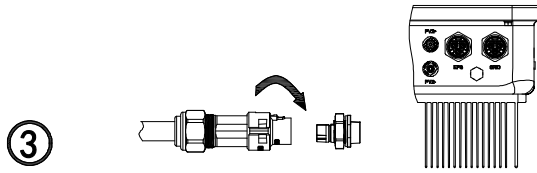

Note: 1. If you use the grid connection function only, connect the power grid to the GRID port of the inverter.

2. Do not connect the GRID port directly to the EPS port, as this could cause damage to the inverter.

3. Do not connect the power grid to the EPS port, as this could cause damage to the inverter.

4. Power cable for GRID port or EPS port:  $\geq 4\text{mm}^2$  (11AWG).

## 5.4 BAT Wiring

Install the battery power cable in the following steps:

1. Unscrew the rubber nut on the waterproof cover of the hybrid inverter;
2. Pass the cable through the rubber nut, sealing ring, threaded sleeve and waterproof cover in turn;
3. Crimp the battery cable (supplied in the original package) to the corresponding O-terminal,
4. and then connect the positive (negative) terminal of the battery to the positive (negative) end of the battery terminal of the inverter.

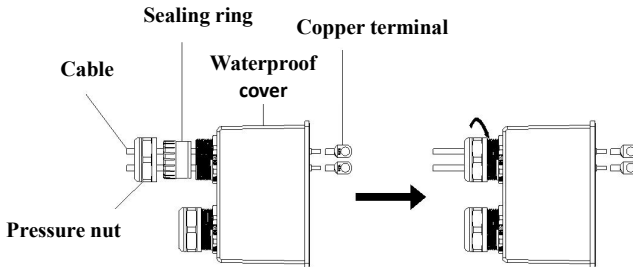

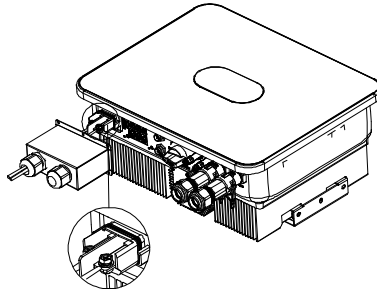

Note: 1. A DC switch is required between the battery and the inverter.

2. Power cable between the battery and the inverter:  $\leq 1.5\text{m}$  in length,  $\geq 16\text{mm}^2$  (5AWG) in cross sectional area.

## 5.5. Communication Connection

### 5.5.1 Connection of Lithium Battery

To use a lithium battery, you need to connect the BMS system of the lithium battery in the following steps:

1. Unscrew the rubber nut on the waterproof cover of the hybrid inverter;
2. Pass the LAN cable through the rubber nut, sealing ring, threaded sleeve and waterproof cover in turn;
3. Connect the RJ45 terminal of the LAN cable to the BMS port of the hybrid inverter;
4. Lock the waterproof cover with screws;
5. Screw the rubber nut reliably onto the waterproof cover.

#### Definition of RJ45 interface:

	BMS	
Pin 1		
Pin 2		
Pin 3		
Pin 4	CAN-H	
Pin 5	CAN-L	
Pin 6		
Pin 7	GND	
Pin 8	WAKE-UP	

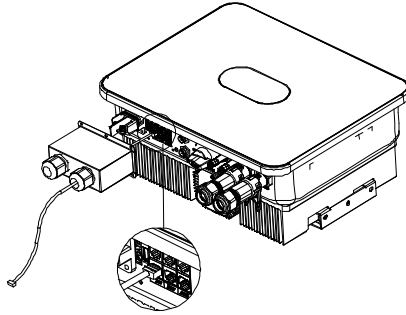

Note: To use a lead-acid battery, you can jump directly to Section 5.5.2 without connecting the Communication cable.

### 5.5.2 Connection of Temperature Sensor

To use a lead-acid battery, you need to connect a temperature sensor to monitor the surface temperature of the battery. Connect the temperature sensor in the following steps:

1. Unscrew the rubber nut on the waterproof cover of the hybrid inverter;
2. Pass the NTC cable through the rubber nut, sealing ring, threaded sleeve and waterproof cover in turn;
3. Connect the RJ45 terminal of the NTC cable to the DRY IO/NTC port of the hybrid inverter;
4. Lock the waterproof cover with screws;
5. Screw the rubber nut reliably onto the waterproof cover.

#### Definition of interface:

	NTC	DRY IO
Pin 1		NC OUT
Pin 2		NC OUT
Pin 3	GND	
Pin 4		COM
Pin 5		COM
Pin 6	TEMP	
Pin 7		NO OUT
Pin 8		NO OUT

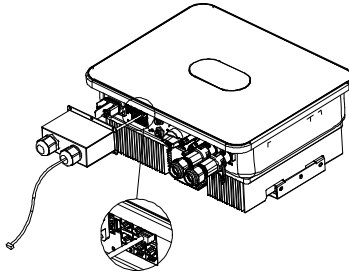

Note: The probe of the temperature sensor used to monitor the ambient temperature of the lead-acid battery should be shorter than 1.5m; if you use lithium battery instead, there is no need to install a temperature sensor.

## 5.6 CT Connection

The current transformer used on the inverter can help monitor the energy use of the home user. Below are the CT connection steps.

1. Unscrew the rubber nut on the waterproof cover of the hybrid inverter;
2. Pass the CT cable through the rubber nut, sealing ring, threaded sleeve and waterproof cover in turn;
3. Connect the RJ45 terminal of the CT cable to the CT port of the hybrid inverter;
4. Lock the waterproof cover with screws;
5. Screw the rubber nut reliably onto the waterproof cover.

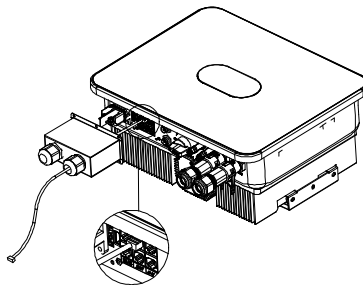

CT cable: 5m in length, RJ45, standard LAN cable (8-pin connector at one end, connecting current transformer at the other end). It can be extended by an extension cable to 15m if necessary. See the figure below.

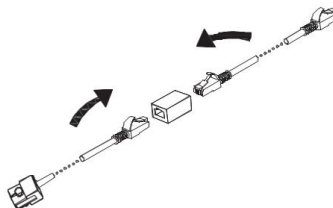



Make sure the current transformer is installed in the correct direction as shown below.

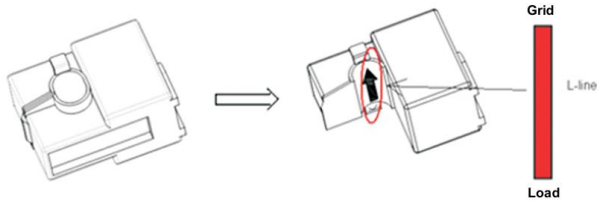

Turn on the current transformer, and you will see an arrow indicating the direction of the current, as shown above. Pass the L wire through the detection hole of the current transformer and then lock the current transformer.

Note: The direction of the arrow (from K to L) corresponds to the direction from load to grid in the L wire. The current transformer should be placed in the distribution box.

The communication distance should be less than 30m.

### 5.7 Connection of Smart Meter

End user can also monitor home consumption by smart meter. You can connect the communication cable of the smart meter as described below.

Connect the smart meter to COM-2 (waterproof RS485 terminal) by plugging and tightening, as shown in the figure below:

Note: You cannot install the smart meter and current transformer at the same time, but select either CT or Meter as the sensor mode as described in Chapter 7.

Below is the connection diagram of CHNT smart meter:

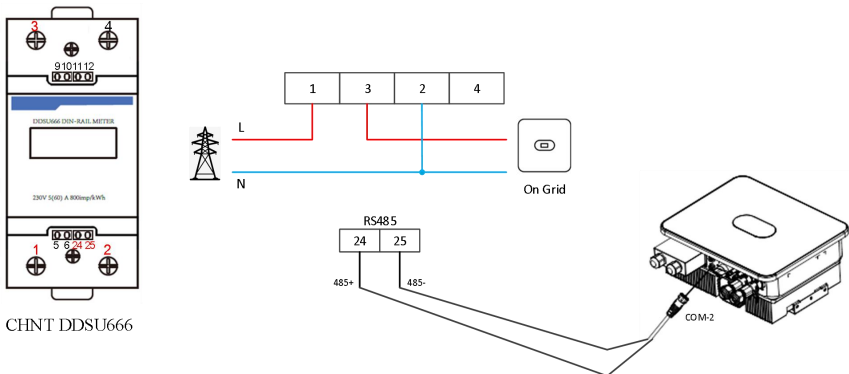

CHNT DDSU666

### 5.8 Connection of Grounding Wire

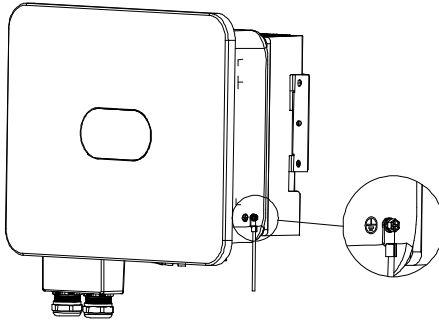

The hybrid inverter should be grounded reliably. The grounding wire should be  $\geq 10\text{mm}^2$ . The grounding point (GND) is shown below.

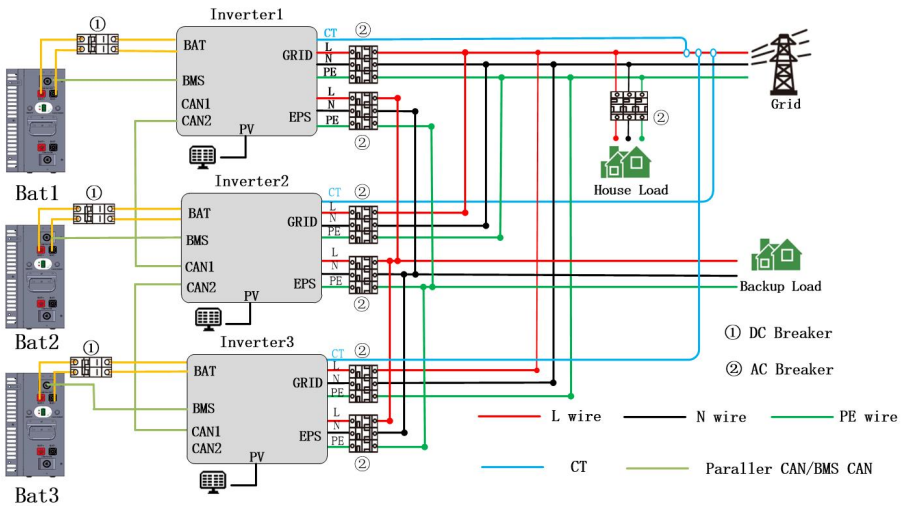

### 5.9 Parallel wiring



Master and slave settings:

<div style="border: 1px solid black; padding: 5px;"> <p style="text-align: center;">Setting Info</p> <p>10. Anti-Reflex Setting</p> <p style="background-color: black; color: white; padding: 2px;">11. Set Parallel Role</p> </div>	 Press the Enter key.	<div style="border: 1px solid black; padding: 5px;"> <p style="text-align: center;">Set Parallel Role</p> <p style="background-color: black; color: white; padding: 2px;">Role: 1 Phase Master</p> <p style="text-align: center; margin-top: 50px;">OK</p> </div>
<div style="border: 1px solid black; padding: 5px;"> <p style="text-align: center;">Set Parallel Role</p> <p style="background-color: black; color: white; padding: 2px;">Role: 1 Phase Master</p> <p style="text-align: center; margin-top: 50px;">OK</p> </div>	 Press the UP or Down button to select the role	<div style="border: 1px solid black; padding: 5px;"> <p style="text-align: center;">Set Parallel Role</p> <p style="background-color: black; color: white; padding: 2px;">Role: 2 Slave</p> <p style="text-align: center; margin-top: 50px;">OK</p> </div>
▼ Press the Enter key		
<div style="border: 1px solid black; padding: 5px;"> <p style="text-align: center;">Set Parallel Role</p> <p>Role: 2 Slave</p> <p style="background-color: black; color: white; text-align: center; margin-top: 20px; width: 50px; margin: 0 auto;">OK</p> </div>	 Press the Enter key.	<div style="border: 1px solid black; padding: 5px;"> <p style="text-align: center;">Set Parallel Role</p> <p>Role: 2 Slave</p> <p style="background-color: black; color: white; text-align: center; margin-top: 20px; width: 50px; margin: 0 auto;">Setting</p> </div>
▼ Waiting for 3S		
		<div style="border: 1px solid black; padding: 5px;"> <p style="text-align: center;">Set Parallel Role</p> <p>Role: 2 Slave</p> <p style="background-color: black; color: white; text-align: center; margin-top: 20px; width: 80px; margin: 0 auto;">Setting Ok!/Fail!</p> </div>

## Chapter 6 Commissioning

### 6.1 Startup

Step 1: Close the AC circuit breaker of the inverter at GRID side.

Step 2: Close the DC circuit breaker of the inverter at BAT side.

Step 3: Close the AC circuit breaker of the inverter at EPS side.

Step 4: Turn on the PV switch of the inverter.

Note: the system will work in On Grid state upon normal connections at PV side, GRID side and BAT side.

The green LED will remain on, and the message “State: On Grid” will appear on the screen of the hybrid inverter.

### 6.2 Shutdown

To stop the operation of the hybrid inverter, please disconnect all energy sources to enter automatic shutdown.

Step 1: Turn off the PV switch.

Step 2: Turn off the BAT switch.

Step 3: Disconnect the power grid.

Both the LED light and LCD screen will be turned off.

Note: At the end of the above steps, please wait at least 5 minutes before proceeding to other operations.

## Chapter 7 Parameter Settings

On the LCD screen, you can check the current state of the system, energy flow diagram, operation information and fault information, or set the language, charge and discharge priority and system time. The main screen shows the energy flow diagram by default.

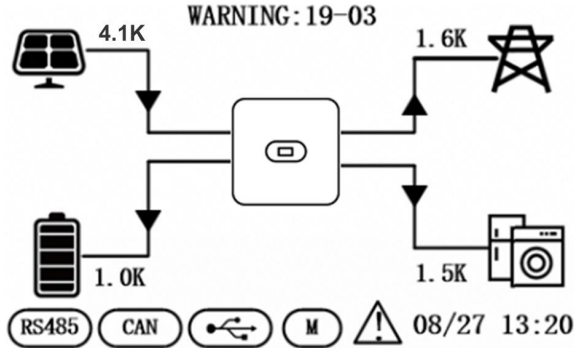

Below are the possible states of the inverter:

1. Initializing: In standby mode when no fault is detected, the inverter gets into waiting state for some reason.
2. Waiting: The inverter enters self-check. If no fault is detected, the system will enter standby mode or normal working mode.
3. On Grid: The inverter is working in on-grid state.
4. Fault: In case of a fault, the inverter will stop working and get into protected mode.
5. Programming: The inverter is currently undergoing program burning .
6. Off Grid: The inverter is working in off-grid state.

### 7.1 Menu Information

On the main screen, press the OK, ESC, Up or Down key to go to the Menu Info page. The Menu Info page is shown below.



Menu Info
1. PV Info
2. AC Output Info
3. BAT Info
4. EPS Output Info
5. Basic Info
6. Energy Info
7. Fault Info
8. Setting Info

On the Menu Info page, press the Up or Down key to select a menu item. The page of each menu item is

shown below.



### 7.1.1 PV Input Information

Here you can check the PV input voltage, current and power.

<table border="1"> <thead> <tr> <th>Menu Info</th> </tr> </thead> <tbody> <tr> <td>1. PV Info</td> </tr> <tr> <td>2. AC Output Info</td> </tr> <tr> <td>3. BAT Info</td> </tr> <tr> <td>4. EPS Output Info</td> </tr> <tr> <td>5. Basic Info</td> </tr> <tr> <td>6. Energy Info</td> </tr> <tr> <td>7. Fault Info</td> </tr> <tr> <td>8. Setting Info</td> </tr> </tbody> </table>	Menu Info	1. PV Info	2. AC Output Info	3. BAT Info	4. EPS Output Info	5. Basic Info	6. Energy Info	7. Fault Info	8. Setting Info	 Press the Enter key to go to the PV Info page.  Press the ESC key to exit the PV Info page.	<table border="1"> <thead> <tr> <th colspan="2">PV Info</th> </tr> </thead> <tbody> <tr> <td>PV Volt:</td> <td>235.6V / 256.8V</td> </tr> <tr> <td>PV Curr:</td> <td>13.6A / 16.8A</td> </tr> <tr> <td>PV Power:</td> <td>3448.9W / 4314.2W</td> </tr> </tbody> </table>	PV Info		PV Volt:	235.6V / 256.8V	PV Curr:	13.6A / 16.8A	PV Power:	3448.9W / 4314.2W
Menu Info																			
1. PV Info																			
2. AC Output Info																			
3. BAT Info																			
4. EPS Output Info																			
5. Basic Info																			
6. Energy Info																			
7. Fault Info																			
8. Setting Info																			
PV Info																			
PV Volt:	235.6V / 256.8V																		
PV Curr:	13.6A / 16.8A																		
PV Power:	3448.9W / 4314.2W																		



### 7.1.2 AC Output Information

Here you can check the AC voltage, frequency and current as well as the meter power.

<table border="1"> <thead> <tr> <th>Menu Info</th> </tr> </thead> <tbody> <tr> <td>1. PV Info</td> </tr> <tr> <td>2. AC Output Info</td> </tr> <tr> <td>3. BAT Info</td> </tr> <tr> <td>4. EPS Output Info</td> </tr> <tr> <td>5. Basic Info</td> </tr> <tr> <td>6. Energy Info</td> </tr> <tr> <td>7. Fault Info</td> </tr> <tr> <td>8. Setting Info</td> </tr> </tbody> </table>	Menu Info	1. PV Info	2. AC Output Info	3. BAT Info	4. EPS Output Info	5. Basic Info	6. Energy Info	7. Fault Info	8. Setting Info	 Press the Enter key to go to the AC Output Info page.  Press the ESC key to exit the AC Output Info page.	<table border="1"> <thead> <tr> <th colspan="2">AC Output Info</th> </tr> </thead> <tbody> <tr> <td>AC Volt:</td> <td>235.6V</td> </tr> <tr> <td>AC Freq:</td> <td>50.1Hz</td> </tr> <tr> <td>AC Curr:</td> <td>30.6A</td> </tr> <tr> <td>METER Power:</td> <td>-2443.3W</td> </tr> </tbody> </table>	AC Output Info		AC Volt:	235.6V	AC Freq:	50.1Hz	AC Curr:	30.6A	METER Power:	-2443.3W
Menu Info																					
1. PV Info																					
2. AC Output Info																					
3. BAT Info																					
4. EPS Output Info																					
5. Basic Info																					
6. Energy Info																					
7. Fault Info																					
8. Setting Info																					
AC Output Info																					
AC Volt:	235.6V																				
AC Freq:	50.1Hz																				
AC Curr:	30.6A																				
METER Power:	-2443.3W																				



### 7.1.3 Battery Information

Here you can check the battery type, voltage, current and power as well as the battery SOC.

<table border="1"> <thead> <tr> <th>Menu Info</th> </tr> </thead> <tbody> <tr> <td>1. PV Info</td> </tr> <tr> <td>2. AC Output Info</td> </tr> <tr style="background-color: black; color: white;"> <td>3. BAT Info</td> </tr> <tr> <td>4. EPS Output Info</td> </tr> <tr> <td>5. Basic Info</td> </tr> <tr> <td>6. Energy Info</td> </tr> <tr> <td>7. Fault Info</td> </tr> <tr> <td>8. Setting Info</td> </tr> </tbody> </table>	Menu Info	1. PV Info	2. AC Output Info	3. BAT Info	4. EPS Output Info	5. Basic Info	6. Energy Info	7. Fault Info	8. Setting Info	 Press the Enter key to go to the Battery Info page. 	<table border="1"> <thead> <tr> <th colspan="2">BAT Info</th> </tr> </thead> <tbody> <tr> <td>BAT Type:</td> <td>lead acid</td> </tr> <tr> <td>BAT Volt:</td> <td>47.3V</td> </tr> <tr> <td>BAT Curr:</td> <td>97.5A</td> </tr> <tr> <td>BAT Power:</td> <td>4526.6W</td> </tr> <tr> <td>BAT SOC:</td> <td>87%</td> </tr> </tbody> </table>	BAT Info		BAT Type:	lead acid	BAT Volt:	47.3V	BAT Curr:	97.5A	BAT Power:	4526.6W	BAT SOC:	87%
Menu Info																							
1. PV Info																							
2. AC Output Info																							
3. BAT Info																							
4. EPS Output Info																							
5. Basic Info																							
6. Energy Info																							
7. Fault Info																							
8. Setting Info																							
BAT Info																							
BAT Type:	lead acid																						
BAT Volt:	47.3V																						
BAT Curr:	97.5A																						
BAT Power:	4526.6W																						
BAT SOC:	87%																						
	Press the ESC key to exit the Battery Info page.																						

### 7.1.4 EPS Output Information

Here you can check the EPS voltage, frequency, current and power as well as the load power.

<table border="1"> <thead> <tr> <th>Menu Info</th> </tr> </thead> <tbody> <tr> <td>1. PV Info</td> </tr> <tr> <td>2. AC Output Info</td> </tr> <tr> <td>3. BAT Info</td> </tr> <tr style="background-color: black; color: white;"> <td>4. EPS Output Info</td> </tr> <tr> <td>5. Basic Info</td> </tr> <tr> <td>6. Energy Info</td> </tr> <tr> <td>7. Fault Info</td> </tr> <tr> <td>8. Setting Info</td> </tr> </tbody> </table>	Menu Info	1. PV Info	2. AC Output Info	3. BAT Info	4. EPS Output Info	5. Basic Info	6. Energy Info	7. Fault Info	8. Setting Info	 Press the Enter key to go to the EPS Output Info page. 	<table border="1"> <thead> <tr> <th colspan="2">EPS Output Info</th> </tr> </thead> <tbody> <tr> <td>EPS Volt:</td> <td>230.5V</td> </tr> <tr> <td>EPS Freq:</td> <td>50.0Hz</td> </tr> <tr> <td>EPS Curr:</td> <td>10.6A</td> </tr> <tr> <td>EPS Power:</td> <td>2443.3W</td> </tr> </tbody> </table>	EPS Output Info		EPS Volt:	230.5V	EPS Freq:	50.0Hz	EPS Curr:	10.6A	EPS Power:	2443.3W
Menu Info																					
1. PV Info																					
2. AC Output Info																					
3. BAT Info																					
4. EPS Output Info																					
5. Basic Info																					
6. Energy Info																					
7. Fault Info																					
8. Setting Info																					
EPS Output Info																					
EPS Volt:	230.5V																				
EPS Freq:	50.0Hz																				
EPS Curr:	10.6A																				
EPS Power:	2443.3W																				
	Press the ESC key to exit the EPS Output Info page.																				

### 7.1.5 Basic Information

Here you can check the date & time, rated power, serial number, communication address and firmware version.

Menu Info	→	Basic Info
<ul style="list-style-type: none"> <li>1. PV Info</li> <li>2. AC Output Info</li> <li>3. BAT Info</li> <li>4. EPS Output Info</li> <li style="background-color: black; color: white;">5. Basic Info</li> <li>6. Energy Info</li> <li>7. Fault Info</li> <li>8. Setting Info</li> </ul>	<p>Press the Enter key to go to the Basic Info page.</p> <p style="text-align: center;">←</p> <p>Press the ESC key to exit the Basic Info page.</p>	<ul style="list-style-type: none"> <li>Date &amp; Time : 22/08/23 11:40</li> <li>Rate Power : 6000W</li> <li>Model: 00F0-0980-0030-0900</li> <li>SN: F00123456790</li> <li>COM Addr: 1</li> <li>FW: 510-012-109-1102</li> </ul>

### 7.1.6 Energy Information

Here you can check daily and total energy generated by inverter, as well as daily battery charging/discharging energy and total battery charging/discharging energy.

Menu Info	→	Energy Info
<ul style="list-style-type: none"> <li>1. PV Info</li> <li>2. AC Output Info</li> <li>3. BAT Info</li> <li>4. EPS Output Info</li> <li>5. Basic Info</li> <li style="background-color: black; color: white;">6. Energy Info</li> <li>7. Fault Info</li> <li>8. Setting Info</li> </ul>	<p>Press the Enter key to go to the Energy Info page.</p> <p style="text-align: center;">←</p> <p>Press the ESC key to exit the Energy Info page.</p>	<ul style="list-style-type: none"> <li>Energy Today: 23.5KWh</li> <li>Energy Total: 23.5KWh</li> <li>BAT Charge Today: 23.5KWh</li> <li>BAT Charge Total: 23.5KWh</li> <li>BAT Discharge Today: 23.5KWh</li> <li>BAT Discharge Total: 23.5KWh</li> </ul>



### 7.1.7 Fault Information

Here you can check the total number of fault logs as well as the fault code, date and time of each fault.

<table border="1" style="width: 100%; border-collapse: collapse;"> <thead> <tr> <th style="text-align: center;">Menu Info</th> </tr> </thead> <tbody> <tr><td>1. PV Info</td></tr> <tr><td>2. AC Output Info</td></tr> <tr><td>3. BAT Info</td></tr> <tr><td>4. EPS Output Info</td></tr> <tr><td>5. Basic Info</td></tr> <tr><td>6. Energy Info</td></tr> <tr style="background-color: black; color: white;"><td>7. Fault Info</td></tr> <tr><td>8. Setting Info</td></tr> </tbody> </table>	Menu Info	1. PV Info	2. AC Output Info	3. BAT Info	4. EPS Output Info	5. Basic Info	6. Energy Info	7. Fault Info	8. Setting Info	<p>→</p> <p>Press the Enter key to go to the Fault Info page.</p> <p>←</p> <p>Press the ESC key to exit the Fault Info page.</p>	<table border="1" style="width: 100%; border-collapse: collapse;"> <thead> <tr> <th style="text-align: center;">Fault Info</th> </tr> </thead> <tbody> <tr><td>Total Log Num</td><td style="text-align: right;">12</td></tr> <tr style="background-color: black; color: white;"><td>1: F31-08</td></tr> <tr><td>DATE: 22/08/23 16:01:23</td></tr> <tr style="background-color: black; color: white;"><td>2: F09-08</td></tr> <tr><td>DATE: 22/07/23 16:01:23</td></tr> <tr style="background-color: black; color: white;"><td>3: F31-08</td></tr> <tr><td>DATE: 22/08/23 16:01:23</td></tr> <tr style="background-color: black; color: white;"><td>4: F31-08</td></tr> <tr><td>DATE: 22/08/23 16:01:23</td></tr> </tbody> </table>	Fault Info	Total Log Num	12	1: F31-08	DATE: 22/08/23 16:01:23	2: F09-08	DATE: 22/07/23 16:01:23	3: F31-08	DATE: 22/08/23 16:01:23	4: F31-08	DATE: 22/08/23 16:01:23
Menu Info																						
1. PV Info																						
2. AC Output Info																						
3. BAT Info																						
4. EPS Output Info																						
5. Basic Info																						
6. Energy Info																						
7. Fault Info																						
8. Setting Info																						
Fault Info																						
Total Log Num	12																					
1: F31-08																						
DATE: 22/08/23 16:01:23																						
2: F09-08																						
DATE: 22/07/23 16:01:23																						
3: F31-08																						
DATE: 22/08/23 16:01:23																						
4: F31-08																						
DATE: 22/08/23 16:01:23																						

### 7.1.8 Setup Information

To access the Setting Info page, you need to enter the password. On the Menu Info page, select “Setting Info” to go to the Input Password page.

<table border="1" style="width: 100%; border-collapse: collapse;"> <thead> <tr> <th style="text-align: center;">Menu Info</th> </tr> </thead> <tbody> <tr><td>1. PV Info</td></tr> <tr><td>2. AC Output Info</td></tr> <tr><td>3. BAT Info</td></tr> <tr><td>4. EPS Output Info</td></tr> <tr><td>5. Basic Info</td></tr> <tr><td>6. Energy Info</td></tr> <tr><td>7. Fault Info</td></tr> <tr style="background-color: black; color: white;"><td>8. Setting Info</td></tr> </tbody> </table>	Menu Info	1. PV Info	2. AC Output Info	3. BAT Info	4. EPS Output Info	5. Basic Info	6. Energy Info	7. Fault Info	8. Setting Info	<p>→</p> <p>Press the Enter key to go to the Fault Info page.</p> <p>←</p> <p>Press the ESC key to exit the Fault Info page.</p>	<table border="1" style="width: 100%; border-collapse: collapse;"> <thead> <tr> <th style="text-align: center;">Input Password</th> </tr> </thead> <tbody> <tr> <td style="padding: 10px;">                     Password :      <span style="background-color: black; color: white; padding: 2px 5px;">0</span> 0 0                       OK                 </td> </tr> </tbody> </table>	Input Password	Password : <span style="background-color: black; color: white; padding: 2px 5px;">0</span> 0 0  OK
Menu Info													
1. PV Info													
2. AC Output Info													
3. BAT Info													
4. EPS Output Info													
5. Basic Info													
6. Energy Info													
7. Fault Info													
8. Setting Info													
Input Password													
Password : <span style="background-color: black; color: white; padding: 2px 5px;">0</span> 0 0  OK													

Enter the password in the following steps.

<table border="1" style="width: 100%; border-collapse: collapse;"> <thead> <tr> <th style="text-align: center;">Input Password</th> </tr> </thead> <tbody> <tr> <td style="padding: 10px;">                     Password :      <span style="background-color: black; color: white; padding: 2px 5px;">0</span> 0 0                       OK                 </td> </tr> </tbody> </table>	Input Password	Password : <span style="background-color: black; color: white; padding: 2px 5px;">0</span> 0 0  OK	<p>→</p> <p>Press the Up or Down key to increase or reduce the number.</p>	<table border="1" style="width: 100%; border-collapse: collapse;"> <thead> <tr> <th style="text-align: center;">Input Password</th> </tr> </thead> <tbody> <tr> <td style="padding: 10px;">                     Password :      <span style="background-color: black; color: white; padding: 2px 5px;">1</span> 0 0                       OK                 </td> </tr> </tbody> </table>	Input Password	Password : <span style="background-color: black; color: white; padding: 2px 5px;">1</span> 0 0  OK
Input Password						
Password : <span style="background-color: black; color: white; padding: 2px 5px;">0</span> 0 0  OK						
Input Password						
Password : <span style="background-color: black; color: white; padding: 2px 5px;">1</span> 0 0  OK						

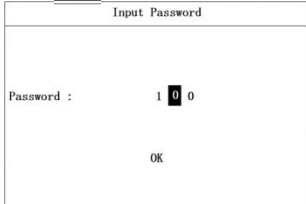
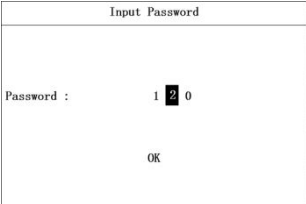
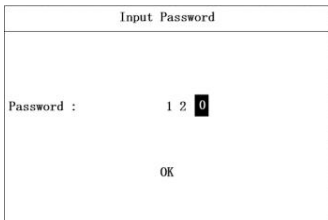
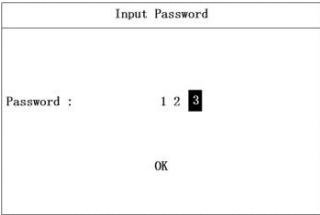
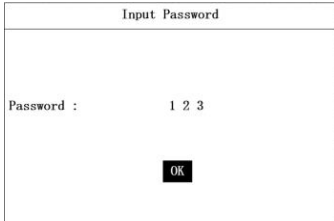
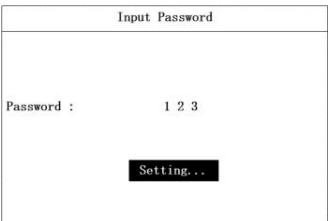
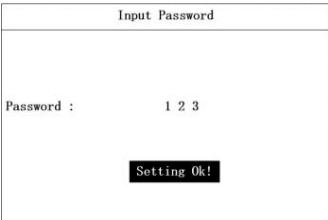



<p>▼ Press the Enter key.</p> 	<p>→</p> <p>Press the Up or Down key to increase or reduce the number.</p>	
<p>▼ Press the Enter key.</p> 	<p>→</p> <p>Press the Up or Down key to increase or reduce the number.</p>	
<p>▼ Press the Enter key.</p> 	<p>→</p> <p>Press the Up or Down key to increase or reduce the number.</p>	
		<p>▼ Wait for 3 seconds.</p>
		







## 7.2 “Setting Info” Page

On the Setting Info page, you can set such parameters as the date & time, COM address, language, country and priority. Some parameters need to be allowed to be set in standby mode, and the green and yellow lights on the screen panel will not remain permanently on during standby mode. The Setting Info page is shown below.

Setting Info
1. Date & Time Setting
2. COM Address Setting
3. Language Setting
4:BAT & Meter Setting
5. Country Setting
6. Off Grid Setting
7. Priority Setting
8. AutoTest Setting
9. Restore Factory Setting

**7.2.1 Date & Time Setting**

<div style="border: 1px solid black; padding: 5px;"> <p style="text-align: center;">Setting Info</p> <p>1. Date &amp; Time Setting</p> <p>2. COM Address Setting</p> <p>3. Language Setting</p> <p>4:BAT &amp; Meter Setting</p> <p>5. Country Setting</p> <p>6. Off Grid Setting</p> <p>7. Priority Setting</p> <p>8. AutoTest Setting</p> <p>9. Restore Factory Setting</p> </div>	 Press the Enter key.	<div style="border: 1px solid black; padding: 5px;"> <p style="text-align: center;">Date &amp; Time Setting</p> <p>Day-Month-Year: 24 / 02 / 23</p> <p>Hour-Min-Sec: 19: 41 : 39</p> <p style="text-align: center;">OK</p> </div>
<div style="border: 1px solid black; padding: 5px;"> <p style="text-align: center;">Date &amp; Time Setting</p> <p>Day-Month-Year: 24 / 02 / 23</p> <p>Hour-Min-Sec: 19: 41 : 39</p> <p style="text-align: center;">OK</p> </div>	 Press the Up or Down key to increase or reduce the number.	<div style="border: 1px solid black; padding: 5px;"> <p style="text-align: center;">Date &amp; Time Setting</p> <p>Day-Month-Year: 25 / 08 / 22</p> <p>Hour-Min-Sec: 19:41:39</p> <p style="text-align: center;">OK</p> </div>
 Press the Enter key.		
<div style="border: 1px solid black; padding: 5px;"> <p style="text-align: center;">Date &amp; Time Setting</p> <p>Day-Month-Year: 25 / 08 / 22</p> <p>Hour-Min-Sec: 19:41:39</p> <p style="text-align: center;">OK</p> </div>	 Press the Up or Down key to increase or reduce the number.	<div style="border: 1px solid black; padding: 5px;"> <p style="text-align: center;">Date &amp; Time Setting</p> <p>Day-Month-Year: 25 / 09 / 22</p> <p>Hour-Min-Sec: 19:41:39</p> <p style="text-align: center;">OK</p> </div>
 Press the Enter key.		

<p style="text-align: center;">Date &amp; Time Setting</p> <hr/> <p>Day-Month-Year: 25 / 08 / <b>22</b>          Hour-Min-Sec: 19:41:39</p> <p style="text-align: center;">OK</p>	 <p>Press the Up or Down key to increase or reduce the number.</p>	<p style="text-align: center;">Date &amp; Time Setting</p> <hr/> <p>Day-Month-Year: 25 / 08 / <b>23</b>          Hour-Min-Sec: 19:41:39</p> <p style="text-align: center;">OK</p>
 Press the Enter key.		
<p style="text-align: center;">Date &amp; Time Setting</p> <hr/> <p>Day-Month-Year: 25 / 08 / 22          Hour-Min-Sec: 19: <b>41</b> :39</p> <p style="text-align: center;">OK</p>	 <p>Press the Up or Down key to increase or reduce the number.</p>	<p style="text-align: center;">Date &amp; Time Setting</p> <hr/> <p>Day-Month-Year: 25 / 08 / 22          Hour-Min-Sec: 19: <b>42</b> :39</p> <p style="text-align: center;">OK</p>
 Press the Enter key.		
<p style="text-align: center;">Date &amp; Time Setting</p> <hr/> <p>Day-Month-Year: 25 / 08 / 22          Hour-Min-Sec: 19: <b>41</b> :39</p> <p style="text-align: center;">OK</p>	 <p>Press the Up or Down key to increase or reduce the number.</p>	<p style="text-align: center;">Date &amp; Time Setting</p> <hr/> <p>Day-Month-Year: 25 / 08 / 22          Hour-Min-Sec: 19: <b>42</b> :39</p> <p style="text-align: center;">OK</p>
 Press the Enter key.		
<p style="text-align: center;">Date &amp; Time Setting</p> <hr/> <p>Day-Month-Year: 25 / 08 / 22          Hour-Min-Sec: 19:41: <b>39</b></p> <p style="text-align: center;">OK</p>	 <p>Press the Up or Down key to increase or reduce the number.</p>	<p style="text-align: center;">Date &amp; Time Setting</p> <hr/> <p>Day-Month-Year: 25 / 08 / 22          Hour-Min-Sec: 19:41: <b>40</b></p> <p style="text-align: center;">OK</p>
Press the Enter key.		

<p style="text-align: center;">Date &amp; Time Setting</p> <hr/> <p>Day-Month-Year: 25 / 08 / 22          Hour-Min-Sec: 19:41:39</p> <p style="text-align: center;"><b>OK</b></p>	<p>→</p> <p>Press the Enter key.</p>	<p style="text-align: center;">Date &amp; Time Setting</p> <hr/> <p>Day-Month-Year: 25 / 08 / 22          Hour-Min-Sec: 19:41:39</p> <p style="text-align: center;"><b>Setting...</b></p>
		<p>▼ Wait for 3 seconds.</p>
		<p style="text-align: center;">Date &amp; Time Setting</p> <hr/> <p>Day-Month-Year: 25 / 08 / 22          Hour-Min-Sec: 19:41:39</p> <p style="text-align: center;"><b>Setting OK!</b></p>

7.2.2 COM Address Setting

<p style="text-align: center;">Setting Info</p> <hr/> <p>1.Date &amp; Time Setting  <b>2.COM Address Setting</b>          3.Language Setting          4.BAT &amp; Meter Setting          5.Country Setting          6.Off Grid Setting          7.Priority Setting          8.AutoTest Setting          9.Restore Factory Setting</p>	<p>→</p> <p>Press the Enter key.</p>	<p style="text-align: center;">COM Address Setting</p> <hr/> <p>Address: <b>0</b> 0 1</p> <p style="text-align: center;">OK</p>
<p style="text-align: center;">COM Address Setting</p> <hr/> <p>Address: <b>0</b> 0 1</p> <p style="text-align: center;">OK</p>	<p>→</p> <p>Press the Up or Down key to increase or reduce the number.</p>	<p style="text-align: center;">COM Address Setting</p> <hr/> <p>Address: <b>1</b> 0 1</p> <p style="text-align: center;">OK</p>
<p>▼ Press the Enter key.</p>		

<p>COM Address Setting</p> <p>Address:      0 0 1</p> <p>                  OK</p>	<p style="text-align: center;">→</p> <p>Press the Up or Down key to increase or reduce the number.</p>	<p>COM Address Setting</p> <p>Address:      0 1 1</p> <p>                  OK</p>
<p style="text-align: center;">▼ Press the Enter key.</p>		
<p>COM Address Setting</p> <p>Address:      0 0 1</p> <p>                  OK</p>	<p style="text-align: center;">→</p> <p>Press the Up or Down key to increase or reduce the number.</p>	<p>COM Address Setting</p> <p>Address:      0 0 2</p> <p>                  OK</p>
<p style="text-align: center;">▼ Press the Enter key.</p>		
<p>COM Address Setting</p> <p>Address:      0 0 1</p> <p>                  OK</p>	<p style="text-align: center;">→</p> <p>Press the Enter key.</p>	<p>COM Address Setting</p> <p>Address:      0 0 1</p> <p>                  Setting...</p>
<p style="text-align: center;">▼ Wait for 3 seconds.</p>		
		<p>COM Address Setting</p> <p>Address:      0 0 1</p> <p>                  Setting Ok!</p>

### 7.2.3 Language Setting

<table border="1"> <tr><td>Setting Info</td></tr> <tr><td>1.Date &amp; Time Setting</td></tr> <tr><td>2.COM Address Setting</td></tr> <tr><td><b>3.Language Setting</b></td></tr> <tr><td>4:BAT &amp; Meter Setting</td></tr> <tr><td>5.Country Setting</td></tr> <tr><td>6.Off Grid Setting</td></tr> <tr><td>7.Priority Setting</td></tr> <tr><td>8.AutoTest Setting</td></tr> <tr><td>9.Restore Factory Setting</td></tr> </table>	Setting Info	1.Date & Time Setting	2.COM Address Setting	<b>3.Language Setting</b>	4:BAT & Meter Setting	5.Country Setting	6.Off Grid Setting	7.Priority Setting	8.AutoTest Setting	9.Restore Factory Setting	<p style="text-align: center;">→</p> <p>Press the Enter key.</p>	<table border="1"> <tr><td>Language Setting</td></tr> <tr><td><b>1.English</b></td></tr> </table>	Language Setting	<b>1.English</b>
Setting Info														
1.Date & Time Setting														
2.COM Address Setting														
<b>3.Language Setting</b>														
4:BAT & Meter Setting														
5.Country Setting														
6.Off Grid Setting														
7.Priority Setting														
8.AutoTest Setting														
9.Restore Factory Setting														
Language Setting														
<b>1.English</b>														
<table border="1"> <tr><td>Language Setting</td></tr> <tr><td><b>1.English</b></td></tr> </table>	Language Setting	<b>1.English</b>	<p style="text-align: center;">→</p> <p>Press the Enter key.</p>	<table border="1"> <tr><td>Language Setting</td></tr> <tr><td>Language: English</td></tr> <tr><td><b>Setting...</b></td></tr> </table>	Language Setting	Language: English	<b>Setting...</b>							
Language Setting														
<b>1.English</b>														
Language Setting														
Language: English														
<b>Setting...</b>														
		<p style="text-align: center;">▼ Wait for 3 seconds.</p>												
		<table border="1"> <tr><td>Language Setting</td></tr> <tr><td>Language: English</td></tr> <tr><td><b>Setting Ok!</b></td></tr> </table>	Language Setting	Language: English	<b>Setting Ok!</b>									
Language Setting														
Language: English														
<b>Setting Ok!</b>														

### 7.2.4 Meter Settings

On the BAT & Meter Setting page, you can select the CT mode or a meter manufacturer. See the following steps.

<table border="1"> <tr><td>Setting Info</td></tr> <tr><td>1.Date &amp; Time Setting</td></tr> <tr><td>2.COM Address Setting</td></tr> <tr><td>3.Language Setting</td></tr> <tr><td><b>4:Bat &amp; Meter Setting</b></td></tr> <tr><td>5.Country Setting</td></tr> <tr><td>6.Off Grid Setting</td></tr> <tr><td>7.Priority Setting</td></tr> <tr><td>8.AutoTest Setting</td></tr> <tr><td>9.Restore Factory Setting</td></tr> </table>	Setting Info	1.Date & Time Setting	2.COM Address Setting	3.Language Setting	<b>4:Bat &amp; Meter Setting</b>	5.Country Setting	6.Off Grid Setting	7.Priority Setting	8.AutoTest Setting	9.Restore Factory Setting	<p style="text-align: center;">→</p> <p>Press the Enter key.</p>	<table border="1"> <tr><td>Bat &amp; Meter Setting:</td></tr> <tr><td>Sensor: <b>CT</b></td></tr> <tr><td>BAT Mfr: Lead-Acid</td></tr> <tr><td>CV: 58V</td></tr> <tr><td>CC: 60A</td></tr> <tr><td>LV: 48V</td></tr> <tr><td>OK</td></tr> </table>	Bat & Meter Setting:	Sensor: <b>CT</b>	BAT Mfr: Lead-Acid	CV: 58V	CC: 60A	LV: 48V	OK
Setting Info																			
1.Date & Time Setting																			
2.COM Address Setting																			
3.Language Setting																			
<b>4:Bat &amp; Meter Setting</b>																			
5.Country Setting																			
6.Off Grid Setting																			
7.Priority Setting																			
8.AutoTest Setting																			
9.Restore Factory Setting																			
Bat & Meter Setting:																			
Sensor: <b>CT</b>																			
BAT Mfr: Lead-Acid																			
CV: 58V																			
CC: 60A																			
LV: 48V																			
OK																			

<p>Bat &amp; Meter Setting:</p> <p>Sensor: <b>CT</b></p> <p>BAT Mfr: Lead-Acid</p> <p>CV: 58V</p> <p>CC: 60A</p> <p>LV: 48V</p> <p>OK</p>	<p>→</p> <p>Press the Up or Down key to select the CT mode or a meter manufacturer.</p>	<p>Bat &amp; Meter Setting:</p> <p>Sensor: <b>Eastron</b></p> <p>BAT Mfr: Lead-Acid</p> <p>CV: 58V</p> <p>CC: 60A</p> <p>LV: 48V</p> <p>OK</p>
		<p>▼ Press the Enter key.</p>
		<p>Bat &amp; Meter Setting:</p> <p>Sensor: Eastron</p> <p>BAT Mfr: Lead-Acid</p> <p>CV: 58V</p> <p>CC: 60A</p> <p>LV: 48V</p> <p><b>OK</b></p>
		<p>▼ Press the Enter key.</p>
		<p>Bat &amp; Meter Setting:</p> <p>Sensor: Eastron</p> <p>BAT Mfr: Lead-Acid</p> <p>CV: 58V</p> <p>CC: 60A</p> <p>LV: 48V</p> <p><b>Setting...</b></p>
		<p>▼ Press the Enter key.</p>
		<p>Bat &amp; Meter Setting:</p> <p>Sensor: Eastron</p> <p>BAT Mfr: Lead-Acid</p> <p>CV: 58V</p> <p>CC: 60A</p> <p>LV: 48V</p> <p><b>Setting Ok!</b></p>

### 7.2.5 Battery Parameter Settings

The battery parameters displayed on the Setting Info page depend on the battery manufacturer. If you select “Lead-Acid”, the battery parameters will include Charge Voltage, Charge Current and Low Voltage. If you select a lithium battery manufacturer, the battery parameters will include Charge Current and Discharge Current. You can set the lead-acid battery parameters in the following steps.







<table border="1"> <tr><th colspan="2">Setting Info</th></tr> <tr><td>1.Date &amp; Time Setting</td><td></td></tr> <tr><td>2.COM Address Setting</td><td></td></tr> <tr><td>3.Language Setting</td><td></td></tr> <tr><td><b>4:Bat &amp; Meter Setting</b></td><td></td></tr> <tr><td>5.Country Setting</td><td></td></tr> <tr><td>6.Off Grid Setting</td><td></td></tr> <tr><td>7.Priority Setting</td><td></td></tr> <tr><td>8.AutoTest Setting</td><td></td></tr> <tr><td>9.Restore Factory Setting</td><td></td></tr> </table>	Setting Info		1.Date & Time Setting		2.COM Address Setting		3.Language Setting		<b>4:Bat &amp; Meter Setting</b>		5.Country Setting		6.Off Grid Setting		7.Priority Setting		8.AutoTest Setting		9.Restore Factory Setting		<p style="text-align: center;">→</p> <p>Press the Enter key.</p>	<table border="1"> <tr><th colspan="2">Bat &amp; Meter Setting:</th></tr> <tr><td>Sensor:</td><td>CT</td></tr> <tr><td>BAT Mfr:</td><td>Lead-Acid</td></tr> <tr><td>CV:</td><td>58V</td></tr> <tr><td>CC:</td><td>60A</td></tr> <tr><td>LV:</td><td>48V</td></tr> <tr><td colspan="2" style="text-align: center;">OK</td></tr> </table>	Bat & Meter Setting:		Sensor:	CT	BAT Mfr:	Lead-Acid	CV:	58V	CC:	60A	LV:	48V	OK	
Setting Info																																				
1.Date & Time Setting																																				
2.COM Address Setting																																				
3.Language Setting																																				
<b>4:Bat &amp; Meter Setting</b>																																				
5.Country Setting																																				
6.Off Grid Setting																																				
7.Priority Setting																																				
8.AutoTest Setting																																				
9.Restore Factory Setting																																				
Bat & Meter Setting:																																				
Sensor:	CT																																			
BAT Mfr:	Lead-Acid																																			
CV:	58V																																			
CC:	60A																																			
LV:	48V																																			
OK																																				
<table border="1"> <tr><th colspan="2">Bat &amp; Meter Setting:</th></tr> <tr><td>Sensor:</td><td>CT</td></tr> <tr><td>BAT Mfr:</td><td>Lead-Acid</td></tr> <tr><td>CV:</td><td>58V</td></tr> <tr><td>CC:</td><td>60A</td></tr> <tr><td>LV:</td><td>48V</td></tr> <tr><td colspan="2" style="text-align: center;">OK</td></tr> </table>	Bat & Meter Setting:		Sensor:	CT	BAT Mfr:	Lead-Acid	CV:	58V	CC:	60A	LV:	48V	OK		<p style="text-align: center;">→</p> <p>Press the Up or Down key to select “Lead-Acid” or a lithium battery manufacturer.</p>	<table border="1"> <tr><th colspan="2">Bat &amp; Meter Setting:</th></tr> <tr><td>Sensor:</td><td>CT</td></tr> <tr><td>BAT Mfr:</td><td>ATL</td></tr> <tr><td>CV:</td><td>58V</td></tr> <tr><td>CC:</td><td>60A</td></tr> <tr><td>LV:</td><td>48V</td></tr> <tr><td colspan="2" style="text-align: center;">OK</td></tr> </table>	Bat & Meter Setting:		Sensor:	CT	BAT Mfr:	ATL	CV:	58V	CC:	60A	LV:	48V	OK							
Bat & Meter Setting:																																				
Sensor:	CT																																			
BAT Mfr:	Lead-Acid																																			
CV:	58V																																			
CC:	60A																																			
LV:	48V																																			
OK																																				
Bat & Meter Setting:																																				
Sensor:	CT																																			
BAT Mfr:	ATL																																			
CV:	58V																																			
CC:	60A																																			
LV:	48V																																			
OK																																				
<p>▼ Press the Enter key.</p>																																				
<table border="1"> <tr><th colspan="2">Bat &amp; Meter Setting:</th></tr> <tr><td>Sensor:</td><td>CT</td></tr> <tr><td>BAT Mfr:</td><td>Lead-Acid</td></tr> <tr><td>CV:</td><td>58V</td></tr> <tr><td>CC:</td><td>60A</td></tr> <tr><td>LV:</td><td>48V</td></tr> <tr><td colspan="2" style="text-align: center;">OK</td></tr> </table>	Bat & Meter Setting:		Sensor:	CT	BAT Mfr:	Lead-Acid	CV:	58V	CC:	60A	LV:	48V	OK		<p style="text-align: center;">→</p> <p>Press the Up or Down key to increase or reduce the CV value.</p>	<table border="1"> <tr><th colspan="2">Bat &amp; Meter Setting:</th></tr> <tr><td>Sensor:</td><td>CT</td></tr> <tr><td>BAT Mfr:</td><td>Lead-Acid</td></tr> <tr><td>CV:</td><td>59V</td></tr> <tr><td>CC:</td><td>60A</td></tr> <tr><td>LV:</td><td>48V</td></tr> <tr><td colspan="2" style="text-align: center;">OK</td></tr> </table>	Bat & Meter Setting:		Sensor:	CT	BAT Mfr:	Lead-Acid	CV:	59V	CC:	60A	LV:	48V	OK							
Bat & Meter Setting:																																				
Sensor:	CT																																			
BAT Mfr:	Lead-Acid																																			
CV:	58V																																			
CC:	60A																																			
LV:	48V																																			
OK																																				
Bat & Meter Setting:																																				
Sensor:	CT																																			
BAT Mfr:	Lead-Acid																																			
CV:	59V																																			
CC:	60A																																			
LV:	48V																																			
OK																																				
<p>▼ Press the Enter key.</p>																																				
<table border="1"> <tr><th colspan="2">Bat &amp; Meter Setting:</th></tr> <tr><td>Sensor:</td><td>CT</td></tr> <tr><td>BAT Mfr:</td><td>Lead-Acid</td></tr> <tr><td>CV:</td><td>58V</td></tr> <tr><td>CC:</td><td>60A</td></tr> <tr><td>LV:</td><td>48V</td></tr> <tr><td colspan="2" style="text-align: center;">OK</td></tr> </table>	Bat & Meter Setting:		Sensor:	CT	BAT Mfr:	Lead-Acid	CV:	58V	CC:	60A	LV:	48V	OK		<p style="text-align: center;">→</p> <p>Press the Up or Down key to increase or reduce the CA value.</p>	<table border="1"> <tr><th colspan="2">Bat &amp; Meter Setting:</th></tr> <tr><td>Sensor:</td><td>CT</td></tr> <tr><td>BAT Mfr:</td><td>Lead-Acid</td></tr> <tr><td>CV:</td><td>58V</td></tr> <tr><td>CC:</td><td>61A</td></tr> <tr><td>LV:</td><td>48V</td></tr> <tr><td colspan="2" style="text-align: center;">OK</td></tr> </table>	Bat & Meter Setting:		Sensor:	CT	BAT Mfr:	Lead-Acid	CV:	58V	CC:	61A	LV:	48V	OK							
Bat & Meter Setting:																																				
Sensor:	CT																																			
BAT Mfr:	Lead-Acid																																			
CV:	58V																																			
CC:	60A																																			
LV:	48V																																			
OK																																				
Bat & Meter Setting:																																				
Sensor:	CT																																			
BAT Mfr:	Lead-Acid																																			
CV:	58V																																			
CC:	61A																																			
LV:	48V																																			
OK																																				
<p>▼ Press the Enter key.</p>																																				

<p>Bat &amp; Meter Setting:</p> <p>Sensor: CT</p> <p>BAT Mfr: Lead-Acid</p> <p>CV: 58V</p> <p>CC: 60A</p> <p>LV: 48V</p> <p>OK</p>	<p>→</p> <p>Press the Up or Down key to increase or reduce the LV value.</p>	<p>Bat &amp; Meter Setting:</p> <p>Sensor: CT</p> <p>BAT Mfr: Lead-Acid</p> <p>CV: 58V</p> <p>CC: 60A</p> <p>LV: 49V</p> <p>OK</p>
<p>▼ Press the Enter key.</p>		
<p>Bat &amp; Meter Setting:</p> <p>Sensor: CT</p> <p>BAT Mfr: Lead-Acid</p> <p>CV: 58V</p> <p>CC: 60A</p> <p>LV: 48V</p> <p>OK</p>	<p>→</p> <p>Press the Enter key.</p>	<p>Bat &amp; Meter Setting:</p> <p>Sensor: CT</p> <p>BAT Mfr: Lead-Acid</p> <p>CV: 58V</p> <p>CC: 60A</p> <p>LV: 48V</p> <p>Setting..</p>
<p>▼ Press the Enter key.</p>		
		<p>Bat &amp; Meter Setting:</p> <p>Sensor: CT</p> <p>BAT Mfr: Lead-Acid</p> <p>CV: 58V</p> <p>CC: 60A</p> <p>LV: 48V</p> <p>Setting Ok!</p>



You can set the lithium battery parameters in the following steps.

<p>Setting Info</p> <ol style="list-style-type: none"> <li>1. Date &amp; Time Setting</li> <li>2. COM Address Setting</li> <li>3. Language Setting</li> <li>4. Bat &amp; Meter Setting</li> <li>5. Country Setting</li> <li>6. Off Grid Setting</li> <li>7. Priority Setting</li> <li>8. AutoTest Setting</li> <li>9. Restore Factory Setting</li> </ol>	<p>→</p> <p>Press the Enter key.</p>	<p>Bat &amp; Meter Setting:</p> <p>Sensor: CT</p> <p>BAT Mfr: Lead-Acid</p> <p>CV: 58V</p> <p>CC: 60A</p> <p>LV: 48V</p> <p>OK</p>
<p>▼ Press the Enter key.</p>		

<table border="1"> <thead> <tr> <th colspan="2">Bat &amp; Meter Setting</th> </tr> </thead> <tbody> <tr> <td>Sensor:</td> <td>CT</td> </tr> <tr> <td>BAT Mfr:</td> <td>ATL</td> </tr> <tr> <td>Charge Curr:</td> <td>60A</td> </tr> <tr> <td>Discharge Curr:</td> <td>60A</td> </tr> <tr> <td colspan="2" style="text-align: center;">OK</td> </tr> </tbody> </table>	Bat & Meter Setting		Sensor:	CT	BAT Mfr:	ATL	Charge Curr:	60A	Discharge Curr:	60A	OK		  Press the Up or Down key to select a lithium battery manufacturer.	<table border="1"> <thead> <tr> <th colspan="2">Bat &amp; Meter Setting</th> </tr> </thead> <tbody> <tr> <td>Sensor:</td> <td>CT</td> </tr> <tr> <td>BAT Mfr:</td> <td>VestWoods</td> </tr> <tr> <td>Charge Curr:</td> <td>60A</td> </tr> <tr> <td>Discharge Curr:</td> <td>60A</td> </tr> <tr> <td colspan="2" style="text-align: center;">OK</td> </tr> </tbody> </table>	Bat & Meter Setting		Sensor:	CT	BAT Mfr:	VestWoods	Charge Curr:	60A	Discharge Curr:	60A	OK	
Bat & Meter Setting																										
Sensor:	CT																									
BAT Mfr:	ATL																									
Charge Curr:	60A																									
Discharge Curr:	60A																									
OK																										
Bat & Meter Setting																										
Sensor:	CT																									
BAT Mfr:	VestWoods																									
Charge Curr:	60A																									
Discharge Curr:	60A																									
OK																										
▼ Press the Enter key.																										
<table border="1"> <thead> <tr> <th colspan="2">Bat &amp; Meter Setting</th> </tr> </thead> <tbody> <tr> <td>Sensor:</td> <td>CT</td> </tr> <tr> <td>BAT Mfr:</td> <td>ATL</td> </tr> <tr> <td>Charge Curr:</td> <td>60A</td> </tr> <tr> <td>Discharge Curr:</td> <td>60A</td> </tr> <tr> <td colspan="2" style="text-align: center;">OK</td> </tr> </tbody> </table>	Bat & Meter Setting		Sensor:	CT	BAT Mfr:	ATL	Charge Curr:	60A	Discharge Curr:	60A	OK		  Press the Up or Down key to increase or reduce the maximum charge current value.	<table border="1"> <thead> <tr> <th colspan="2">Bat &amp; Meter Setting</th> </tr> </thead> <tbody> <tr> <td>Sensor:</td> <td>CT</td> </tr> <tr> <td>BAT Mfr:</td> <td>ATL</td> </tr> <tr> <td>Charge Curr:</td> <td>61A</td> </tr> <tr> <td>Discharge Curr:</td> <td>60A</td> </tr> <tr> <td colspan="2" style="text-align: center;">OK</td> </tr> </tbody> </table>	Bat & Meter Setting		Sensor:	CT	BAT Mfr:	ATL	Charge Curr:	61A	Discharge Curr:	60A	OK	
Bat & Meter Setting																										
Sensor:	CT																									
BAT Mfr:	ATL																									
Charge Curr:	60A																									
Discharge Curr:	60A																									
OK																										
Bat & Meter Setting																										
Sensor:	CT																									
BAT Mfr:	ATL																									
Charge Curr:	61A																									
Discharge Curr:	60A																									
OK																										
<table border="1"> <thead> <tr> <th colspan="2">Bat &amp; Meter Setting</th> </tr> </thead> <tbody> <tr> <td>Sensor:</td> <td>CT</td> </tr> <tr> <td>BAT Mfr:</td> <td>ATL</td> </tr> <tr> <td>Charge Curr:</td> <td>60A</td> </tr> <tr> <td>Discharge Curr:</td> <td>60A</td> </tr> <tr> <td colspan="2" style="text-align: center;">OK</td> </tr> </tbody> </table>	Bat & Meter Setting		Sensor:	CT	BAT Mfr:	ATL	Charge Curr:	60A	Discharge Curr:	60A	OK		  Press the Up or Down key to increase or reduce the maximum discharge current value.	<table border="1"> <thead> <tr> <th colspan="2">Bat &amp; Meter Setting</th> </tr> </thead> <tbody> <tr> <td>Sensor:</td> <td>CT</td> </tr> <tr> <td>BAT Mfr:</td> <td>ATL</td> </tr> <tr> <td>Charge Curr:</td> <td>60A</td> </tr> <tr> <td>Discharge Curr:</td> <td>61A</td> </tr> <tr> <td colspan="2" style="text-align: center;">OK</td> </tr> </tbody> </table>	Bat & Meter Setting		Sensor:	CT	BAT Mfr:	ATL	Charge Curr:	60A	Discharge Curr:	61A	OK	
Bat & Meter Setting																										
Sensor:	CT																									
BAT Mfr:	ATL																									
Charge Curr:	60A																									
Discharge Curr:	60A																									
OK																										
Bat & Meter Setting																										
Sensor:	CT																									
BAT Mfr:	ATL																									
Charge Curr:	60A																									
Discharge Curr:	61A																									
OK																										
▼ Press the Enter key.																										
		<table border="1"> <thead> <tr> <th colspan="2">Bat &amp; Meter Setting</th> </tr> </thead> <tbody> <tr> <td>Sensor:</td> <td>CT</td> </tr> <tr> <td>BAT Mfr:</td> <td>ATL</td> </tr> <tr> <td>Charge Curr:</td> <td>60A</td> </tr> <tr> <td>Discharge Curr:</td> <td>60A</td> </tr> <tr> <td colspan="2" style="text-align: center;">OK</td> </tr> </tbody> </table>	Bat & Meter Setting		Sensor:	CT	BAT Mfr:	ATL	Charge Curr:	60A	Discharge Curr:	60A	OK													
Bat & Meter Setting																										
Sensor:	CT																									
BAT Mfr:	ATL																									
Charge Curr:	60A																									
Discharge Curr:	60A																									
OK																										

		 Press the Enter key.												
		<table border="1" style="width: 100%;"> <thead> <tr> <th colspan="2" style="text-align: center;">Bat &amp; Meter Setting</th> </tr> </thead> <tbody> <tr> <td>Sensor:</td> <td style="text-align: right;">CT</td> </tr> <tr> <td>BAT Mfr:</td> <td style="text-align: right;">ATL</td> </tr> <tr> <td>Charge Curr:</td> <td style="text-align: right;">60A</td> </tr> <tr> <td>Discharge Curr:</td> <td style="text-align: right;">60A</td> </tr> <tr> <td colspan="2" style="text-align: center;"> <div style="border: 1px solid black; padding: 2px; display: inline-block;">Setting...</div> </td> </tr> </tbody> </table>	Bat & Meter Setting		Sensor:	CT	BAT Mfr:	ATL	Charge Curr:	60A	Discharge Curr:	60A	<div style="border: 1px solid black; padding: 2px; display: inline-block;">Setting...</div>	
Bat & Meter Setting														
Sensor:	CT													
BAT Mfr:	ATL													
Charge Curr:	60A													
Discharge Curr:	60A													
<div style="border: 1px solid black; padding: 2px; display: inline-block;">Setting...</div>														
		 Wait for 3 seconds.												
		<table border="1" style="width: 100%;"> <thead> <tr> <th colspan="2" style="text-align: center;">Bat &amp; Meter Setting</th> </tr> </thead> <tbody> <tr> <td>Sensor:</td> <td style="text-align: right;">CT</td> </tr> <tr> <td>BAT Mfr:</td> <td style="text-align: right;">ATL</td> </tr> <tr> <td>Charge Curr:</td> <td style="text-align: right;">60A</td> </tr> <tr> <td>Discharge Curr:</td> <td style="text-align: right;">60A</td> </tr> <tr> <td colspan="2" style="text-align: center;"> <div style="border: 1px solid black; padding: 2px; display: inline-block;">Setting Ok!</div> </td> </tr> </tbody> </table>	Bat & Meter Setting		Sensor:	CT	BAT Mfr:	ATL	Charge Curr:	60A	Discharge Curr:	60A	<div style="border: 1px solid black; padding: 2px; display: inline-block;">Setting Ok!</div>	
Bat & Meter Setting														
Sensor:	CT													
BAT Mfr:	ATL													
Charge Curr:	60A													
Discharge Curr:	60A													
<div style="border: 1px solid black; padding: 2px; display: inline-block;">Setting Ok!</div>														

**7.2.6 Country Setting**

<table border="1" style="width: 100%;"> <thead> <tr> <th style="text-align: center;">Setting Info</th> </tr> </thead> <tbody> <tr><td>1. Date &amp; Time Setting</td></tr> <tr><td>2. COM Address Setting</td></tr> <tr><td>3. Language Setting</td></tr> <tr><td>4. BAT &amp; Meter Setting</td></tr> <tr style="background-color: black; color: white;"><td>5. Country Setting</td></tr> <tr><td>6. Off Grid Setting</td></tr> <tr><td>7. Priority Setting</td></tr> <tr><td>8. AutoTest Setting</td></tr> <tr><td>9. Restore Factory Setting</td></tr> </tbody> </table>	Setting Info	1. Date & Time Setting	2. COM Address Setting	3. Language Setting	4. BAT & Meter Setting	5. Country Setting	6. Off Grid Setting	7. Priority Setting	8. AutoTest Setting	9. Restore Factory Setting	 Press the Enter key.	<table border="1" style="width: 100%;"> <thead> <tr> <th style="text-align: center;">Country Setting</th> <th style="text-align: right;">1/2</th> </tr> </thead> <tbody> <tr><td>1. CQC2013</td></tr> <tr style="background-color: black; color: white;"><td>2. SKYWORTH</td></tr> <tr><td>3. EN50549</td></tr> <tr><td>4. ITALY</td></tr> <tr><td>5. SPAIN</td></tr> <tr><td>6. NRS</td></tr> <tr><td>7. HUNARY</td></tr> <tr><td>8. BELGAIN</td></tr> <tr><td>9. AUSTRALIAN WEST</td></tr> </tbody> </table>	Country Setting	1/2	1. CQC2013	2. SKYWORTH	3. EN50549	4. ITALY	5. SPAIN	6. NRS	7. HUNARY	8. BELGAIN	9. AUSTRALIAN WEST	
Setting Info																								
1. Date & Time Setting																								
2. COM Address Setting																								
3. Language Setting																								
4. BAT & Meter Setting																								
5. Country Setting																								
6. Off Grid Setting																								
7. Priority Setting																								
8. AutoTest Setting																								
9. Restore Factory Setting																								
Country Setting	1/2																							
1. CQC2013																								
2. SKYWORTH																								
3. EN50549																								
4. ITALY																								
5. SPAIN																								
6. NRS																								
7. HUNARY																								
8. BELGAIN																								
9. AUSTRALIAN WEST																								
<table border="1" style="width: 100%;"> <thead> <tr> <th style="text-align: center;">Country Setting</th> <th style="text-align: right;">1/2</th> </tr> </thead> <tbody> <tr><td>1. CQC2013</td></tr> <tr style="background-color: black; color: white;"><td>2. SKYWORTH</td></tr> <tr><td>3. EN50549</td></tr> <tr><td>4. ITALY</td></tr> <tr><td>5. SPAIN</td></tr> <tr><td>6. NRS</td></tr> <tr><td>7. HUNARY</td></tr> <tr><td>8. BELGAIN</td></tr> <tr><td>9. AUSTRALIAN WEST</td></tr> </tbody> </table>	Country Setting	1/2	1. CQC2013	2. SKYWORTH	3. EN50549	4. ITALY	5. SPAIN	6. NRS	7. HUNARY	8. BELGAIN	9. AUSTRALIAN WEST	 Press the Up or Down key to select the country associated with the applicable safety standards.	<table border="1" style="width: 100%;"> <thead> <tr> <th style="text-align: center;">Country Setting</th> <th style="text-align: right;">1/2</th> </tr> </thead> <tbody> <tr><td>1. CQC2013</td></tr> <tr><td>2. SKYWORTH</td></tr> <tr style="background-color: black; color: white;"><td>3. EN50549</td></tr> <tr><td>4. ITALY</td></tr> <tr><td>5. SPAIN</td></tr> <tr><td>6. NRS</td></tr> <tr><td>7. HUNARY</td></tr> <tr><td>8. BELGAIN</td></tr> <tr><td>9. AUSTRALIAN WEST</td></tr> </tbody> </table>	Country Setting	1/2	1. CQC2013	2. SKYWORTH	3. EN50549	4. ITALY	5. SPAIN	6. NRS	7. HUNARY	8. BELGAIN	9. AUSTRALIAN WEST
Country Setting	1/2																							
1. CQC2013																								
2. SKYWORTH																								
3. EN50549																								
4. ITALY																								
5. SPAIN																								
6. NRS																								
7. HUNARY																								
8. BELGAIN																								
9. AUSTRALIAN WEST																								
Country Setting	1/2																							
1. CQC2013																								
2. SKYWORTH																								
3. EN50549																								
4. ITALY																								
5. SPAIN																								
6. NRS																								
7. HUNARY																								
8. BELGAIN																								
9. AUSTRALIAN WEST																								
		 Press the Enter key.																						

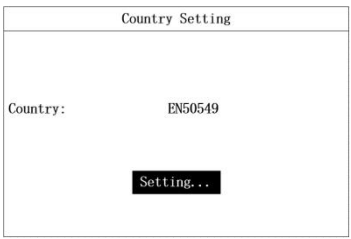
		
		<p><b>▼</b> Wait for 3 seconds.</p>
		

**7.2.7 Off Grid Setting**

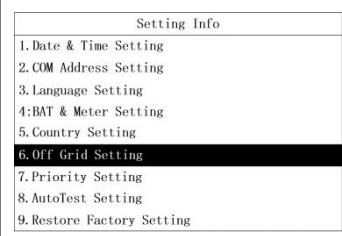
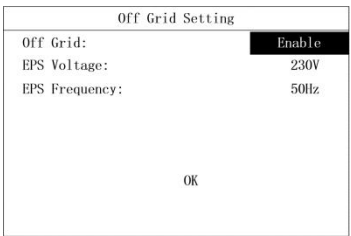
	<p>→</p> <p>Press the Enter key.</p>	
---	--------------------------------------	--

Disable the off-grid mode in the following steps.

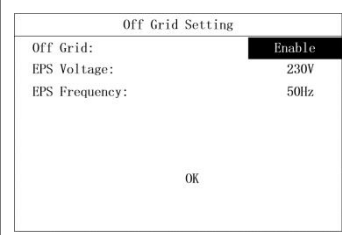
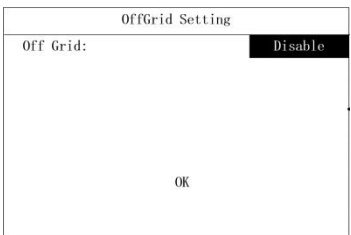
	<p>→</p> <p>Press the Up or Down key to select “Enable” or “Disable”.</p>	
		<p><b>▼</b> Press the Enter key.</p>

		<div style="border: 1px solid black; padding: 5px;"> <p style="text-align: center;">OffGrid Setting</p> <p>Off Grid: <span style="float: right;">Disable</span></p> <p style="text-align: center; margin-top: 20px;"><b>OK</b></p> </div>
		<p><b>▼</b> Press the Enter key.</p>
		<div style="border: 1px solid black; padding: 5px;"> <p style="text-align: center;">OffGrid Setting</p> <p>Off Grid: <span style="float: right;">Disable</span></p> <p style="text-align: center; margin-top: 20px;"><b>Setting...</b></p> </div>
		<p><b>▼</b> Wait for 3 seconds.</p>
		<div style="border: 1px solid black; padding: 5px;"> <p style="text-align: center;">OffGrid Setting</p> <p>Off Grid: <span style="float: right;">Disable</span></p> <p style="text-align: center; margin-top: 20px;"><b>Setting OK!</b></p> </div>

Enable the off-grid mode and set the EPS voltage and frequency in the following steps.

<div style="border: 1px solid black; padding: 5px;"> <p style="text-align: center;">Off Grid Setting</p> <p>Off Grid: <span style="float: right;"><b>Enable</b></span></p> <p>EPS Voltage: <span style="float: right;">230V</span></p> <p>EPS Frequency: <span style="float: right;">50Hz</span></p> <p style="text-align: center; margin-top: 20px;">OK</p> </div>	<p>→</p> <p>Press the Up or Down key to select “Enable” or “Disable”.</p>	<div style="border: 1px solid black; padding: 5px;"> <p style="text-align: center;">OffGrid Setting</p> <p>Off Grid: <span style="float: right;"><b>Disable</b></span></p> <p style="text-align: center; margin-top: 20px;">OK</p> </div>
		<p><b>▼</b> Press the Enter key.</p>

<div style="border: 1px solid black; padding: 5px;"> <p style="text-align: center;">OffGrid Setting</p> <p>Off Grid: <span style="float: right;">Enable</span></p> <p>EPS Voltage: <span style="float: right;">230V</span></p> <p>EPS Frequency: <span style="float: right;">50Hz</span></p> <p style="text-align: center;">OK</p> </div>	<p>→</p> <p>Press the Up or Down key to increase or reduce the EPS voltage value.</p>	<div style="border: 1px solid black; padding: 5px;"> <p style="text-align: center;">OffGrid Setting</p> <p>Off Grid: <span style="float: right;">Enable</span></p> <p>EPS Voltage: <span style="float: right;">231V</span></p> <p>EPS Frequency: <span style="float: right;">50Hz</span></p> <p style="text-align: center;">OK</p> </div>
<p>▼ Press the Enter key.</p>		
<div style="border: 1px solid black; padding: 5px;"> <p style="text-align: center;">OffGrid Setting</p> <p>Off Grid: <span style="float: right;">Enable</span></p> <p>EPS Voltage: <span style="float: right;">231V</span></p> <p>EPS Frequency: <span style="float: right;">50Hz</span></p> <p style="text-align: center;">OK</p> </div>	<p>→</p> <p>Press the Up or Down key to increase or reduce the EPS frequency value.</p> <p>→</p>	<div style="border: 1px solid black; padding: 5px;"> <p style="text-align: center;">OffGrid Setting</p> <p>Off Grid: <span style="float: right;">Enable</span></p> <p>EPS Voltage: <span style="float: right;">231V</span></p> <p>EPS Frequency: <span style="float: right;">51Hz</span></p> <p style="text-align: center;">OK</p> </div>
<p>▼ Press the Enter key.</p>		
<div style="border: 1px solid black; padding: 5px;"> <p style="text-align: center;">OffGrid Setting</p> <p>Off Grid: <span style="float: right;">Enable</span></p> <p>EPS Voltage: <span style="float: right;">231V</span></p> <p>EPS Frequency: <span style="float: right;">50Hz</span></p> <p style="text-align: center;">OK</p> </div>	<p>Press the Enter key.</p>	<div style="border: 1px solid black; padding: 5px;"> <p style="text-align: center;">OffGrid Setting</p> <p>Off Grid: <span style="float: right;">Enable</span></p> <p>EPS Voltage: <span style="float: right;">231V</span></p> <p>EPS Frequency: <span style="float: right;">50Hz</span></p> <p style="text-align: center;">Setting...</p> </div>
<p>▼ Press the Enter key.</p>		
		<div style="border: 1px solid black; padding: 5px;"> <p style="text-align: center;">OffGrid Setting</p> <p>Off Grid: <span style="float: right;">Enable</span></p> <p>EPS Voltage: <span style="float: right;">231V</span></p> <p>EPS Frequency: <span style="float: right;">50Hz</span></p> <p style="text-align: center;">Setting OK!</p> </div>

### 7.2.8 Priority Setting

Priority setting includes Battery First mode and Grid First mode.

<table border="1"> <tr><th colspan="2">Setting Info</th></tr> <tr><td>1.Date &amp; Time Setting</td><td></td></tr> <tr><td>2.COM Address Setting</td><td></td></tr> <tr><td>3.Language Setting</td><td></td></tr> <tr><td>4:BAT &amp; Meter Setting</td><td></td></tr> <tr><td>5.Country Setting</td><td></td></tr> <tr><td>6.Off Grid Setting</td><td></td></tr> <tr><td><b>7.Priority Setting</b></td><td></td></tr> <tr><td>8.AutoTest Setting</td><td></td></tr> <tr><td>9.Restore Factory Setting</td><td></td></tr> </table>	Setting Info		1.Date & Time Setting		2.COM Address Setting		3.Language Setting		4:BAT & Meter Setting		5.Country Setting		6.Off Grid Setting		<b>7.Priority Setting</b>		8.AutoTest Setting		9.Restore Factory Setting		 Press the Enter key.	<table border="1"> <tr><th colspan="2">Priority Setting</th></tr> <tr><td><b>1.Bat First Setting</b></td><td></td></tr> <tr><td>2.Grid First Setting</td><td></td></tr> </table>	Priority Setting		<b>1.Bat First Setting</b>		2.Grid First Setting	
Setting Info																												
1.Date & Time Setting																												
2.COM Address Setting																												
3.Language Setting																												
4:BAT & Meter Setting																												
5.Country Setting																												
6.Off Grid Setting																												
<b>7.Priority Setting</b>																												
8.AutoTest Setting																												
9.Restore Factory Setting																												
Priority Setting																												
<b>1.Bat First Setting</b>																												
2.Grid First Setting																												

Set the Battery First mode in the following steps.

<table border="1"> <tr><th colspan="2">Priority Setting</th></tr> <tr><td><b>1.Bat First Setting</b></td><td></td></tr> <tr><td>2.Grid First Setting</td><td></td></tr> </table>	Priority Setting		<b>1.Bat First Setting</b>		2.Grid First Setting		 Press the Enter key.	<table border="1"> <tr><th colspan="2">Bat First Setting</th></tr> <tr><td>AC Charge:</td><td><b>Enable</b></td></tr> <tr><td>Time Interval:</td><td>1</td></tr> <tr><td>Time Active:</td><td>Enable</td></tr> <tr><td>Time:</td><td>01:00 - 05:00</td></tr> <tr><td>Stop Charge SOC:</td><td>50%</td></tr> <tr><td>Charge Power:</td><td>50%</td></tr> <tr><td colspan="2" style="text-align: center;">OK</td></tr> </table>	Bat First Setting		AC Charge:	<b>Enable</b>	Time Interval:	1	Time Active:	Enable	Time:	01:00 - 05:00	Stop Charge SOC:	50%	Charge Power:	50%	OK	
Priority Setting																								
<b>1.Bat First Setting</b>																								
2.Grid First Setting																								
Bat First Setting																								
AC Charge:	<b>Enable</b>																							
Time Interval:	1																							
Time Active:	Enable																							
Time:	01:00 - 05:00																							
Stop Charge SOC:	50%																							
Charge Power:	50%																							
OK																								

<table border="1"> <tr><th colspan="2">Bat First Setting</th></tr> <tr><td>AC Charge:</td><td><b>Enable</b></td></tr> <tr><td>Time Interval:</td><td>1</td></tr> <tr><td>Time Active:</td><td>Enable</td></tr> <tr><td>Time:</td><td>01:00 - 05:00</td></tr> <tr><td>Stop Charge SOC:</td><td>50%</td></tr> <tr><td>Charge Power:</td><td>50%</td></tr> <tr><td colspan="2" style="text-align: center;">OK</td></tr> </table>	Bat First Setting		AC Charge:	<b>Enable</b>	Time Interval:	1	Time Active:	Enable	Time:	01:00 - 05:00	Stop Charge SOC:	50%	Charge Power:	50%	OK		 Press the Up or Down key to enable or disable the AC charge function.	<table border="1"> <tr><th colspan="2">Bat First Setting</th></tr> <tr><td>AC Charge:</td><td><b>Disable</b></td></tr> <tr><td>Time Interval:</td><td>1</td></tr> <tr><td>Time Active:</td><td>Enable</td></tr> <tr><td>Time:</td><td>01:00 - 05:00</td></tr> <tr><td>Stop Charge SOC:</td><td>50%</td></tr> <tr><td>Charge Power:</td><td>50%</td></tr> <tr><td colspan="2" style="text-align: center;">OK</td></tr> </table>	Bat First Setting		AC Charge:	<b>Disable</b>	Time Interval:	1	Time Active:	Enable	Time:	01:00 - 05:00	Stop Charge SOC:	50%	Charge Power:	50%	OK	
Bat First Setting																																		
AC Charge:	<b>Enable</b>																																	
Time Interval:	1																																	
Time Active:	Enable																																	
Time:	01:00 - 05:00																																	
Stop Charge SOC:	50%																																	
Charge Power:	50%																																	
OK																																		
Bat First Setting																																		
AC Charge:	<b>Disable</b>																																	
Time Interval:	1																																	
Time Active:	Enable																																	
Time:	01:00 - 05:00																																	
Stop Charge SOC:	50%																																	
Charge Power:	50%																																	
OK																																		

 Press the Enter key.

<table border="1"> <tr><th colspan="2">Bat First Setting</th></tr> <tr><td>AC Charge:</td><td>Disable</td></tr> <tr><td>Time Interval:</td><td><b>1</b></td></tr> <tr><td>Time Active:</td><td>Enable</td></tr> <tr><td>Time:</td><td>01:00 - 05:00</td></tr> <tr><td>Stop Charge SOC:</td><td>50%</td></tr> <tr><td>Charge Power:</td><td>50%</td></tr> <tr><td colspan="2" style="text-align: center;">OK</td></tr> </table>	Bat First Setting		AC Charge:	Disable	Time Interval:	<b>1</b>	Time Active:	Enable	Time:	01:00 - 05:00	Stop Charge SOC:	50%	Charge Power:	50%	OK		 Press the Up or Down key to select a time interval.	<table border="1"> <tr><th colspan="2">Bat First Setting</th></tr> <tr><td>AC Charge:</td><td>Disable</td></tr> <tr><td>Time Interval:</td><td><b>2</b></td></tr> <tr><td>Time Active:</td><td>Enable</td></tr> <tr><td>Time:</td><td>01:00 - 05:00</td></tr> <tr><td>Stop Charge SOC:</td><td>50%</td></tr> <tr><td>Charge Power:</td><td>50%</td></tr> <tr><td colspan="2" style="text-align: center;">OK</td></tr> </table>	Bat First Setting		AC Charge:	Disable	Time Interval:	<b>2</b>	Time Active:	Enable	Time:	01:00 - 05:00	Stop Charge SOC:	50%	Charge Power:	50%	OK	
Bat First Setting																																		
AC Charge:	Disable																																	
Time Interval:	<b>1</b>																																	
Time Active:	Enable																																	
Time:	01:00 - 05:00																																	
Stop Charge SOC:	50%																																	
Charge Power:	50%																																	
OK																																		
Bat First Setting																																		
AC Charge:	Disable																																	
Time Interval:	<b>2</b>																																	
Time Active:	Enable																																	
Time:	01:00 - 05:00																																	
Stop Charge SOC:	50%																																	
Charge Power:	50%																																	
OK																																		



<p><b>▼</b> Press the Enter key.</p> <table border="1" data-bbox="118 185 445 408"> <thead> <tr> <th colspan="2">Bat First Setting</th> </tr> </thead> <tbody> <tr> <td>AC Charge:</td> <td>Disable</td> </tr> <tr> <td>Time Interval:</td> <td>1</td> </tr> <tr> <td>Time Active:</td> <td><b>Enable</b></td> </tr> <tr> <td>Time:</td> <td>01:00 - 05:00</td> </tr> <tr> <td>Stop Charge SOC:</td> <td>50%</td> </tr> <tr> <td>Charge Power:</td> <td>50%</td> </tr> <tr> <td colspan="2">OK</td> </tr> </tbody> </table>	Bat First Setting		AC Charge:	Disable	Time Interval:	1	Time Active:	<b>Enable</b>	Time:	01:00 - 05:00	Stop Charge SOC:	50%	Charge Power:	50%	OK		<p style="text-align: center;"><b>→</b></p> <p>Press the Up or Down key to enable or disable the active time period.</p>	<table border="1" data-bbox="654 185 997 408"> <thead> <tr> <th colspan="2">Bat First Setting</th> </tr> </thead> <tbody> <tr> <td>AC Charge:</td> <td>Disable</td> </tr> <tr> <td>Time Interval:</td> <td>1</td> </tr> <tr> <td>Time Active:</td> <td><b>Disable</b></td> </tr> <tr> <td>Time:</td> <td>01:00 - 05:00</td> </tr> <tr> <td>Stop Charge SOC:</td> <td>50%</td> </tr> <tr> <td>Charge Power:</td> <td>50%</td> </tr> <tr> <td colspan="2">OK</td> </tr> </tbody> </table>	Bat First Setting		AC Charge:	Disable	Time Interval:	1	Time Active:	<b>Disable</b>	Time:	01:00 - 05:00	Stop Charge SOC:	50%	Charge Power:	50%	OK	
Bat First Setting																																		
AC Charge:	Disable																																	
Time Interval:	1																																	
Time Active:	<b>Enable</b>																																	
Time:	01:00 - 05:00																																	
Stop Charge SOC:	50%																																	
Charge Power:	50%																																	
OK																																		
Bat First Setting																																		
AC Charge:	Disable																																	
Time Interval:	1																																	
Time Active:	<b>Disable</b>																																	
Time:	01:00 - 05:00																																	
Stop Charge SOC:	50%																																	
Charge Power:	50%																																	
OK																																		
<p><b>▼</b> Press the Enter key.</p> <table border="1" data-bbox="118 531 445 754"> <thead> <tr> <th colspan="2">Bat First Setting</th> </tr> </thead> <tbody> <tr> <td>AC Charge:</td> <td>Disable</td> </tr> <tr> <td>Time Interval:</td> <td>1</td> </tr> <tr> <td>Time Active:</td> <td>Enable</td> </tr> <tr> <td>Time:</td> <td><b>01</b>:00 - 05:00</td> </tr> <tr> <td>Stop Charge SOC:</td> <td>50%</td> </tr> <tr> <td>Charge Power:</td> <td>50%</td> </tr> <tr> <td colspan="2">OK</td> </tr> </tbody> </table>	Bat First Setting		AC Charge:	Disable	Time Interval:	1	Time Active:	Enable	Time:	<b>01</b> :00 - 05:00	Stop Charge SOC:	50%	Charge Power:	50%	OK		<p style="text-align: center;"><b>→</b></p> <p>Press the Up or Down key to increase or reduce the time duration.</p>	<table border="1" data-bbox="654 531 997 754"> <thead> <tr> <th colspan="2">Bat First Setting</th> </tr> </thead> <tbody> <tr> <td>AC Charge:</td> <td>Disable</td> </tr> <tr> <td>Time Interval:</td> <td>1</td> </tr> <tr> <td>Time Active:</td> <td>Enable</td> </tr> <tr> <td>Time:</td> <td>01:00 - <b>02</b>:00</td> </tr> <tr> <td>Stop Charge SOC:</td> <td>50%</td> </tr> <tr> <td>Charge Power:</td> <td>50%</td> </tr> <tr> <td colspan="2">OK</td> </tr> </tbody> </table>	Bat First Setting		AC Charge:	Disable	Time Interval:	1	Time Active:	Enable	Time:	01:00 - <b>02</b> :00	Stop Charge SOC:	50%	Charge Power:	50%	OK	
Bat First Setting																																		
AC Charge:	Disable																																	
Time Interval:	1																																	
Time Active:	Enable																																	
Time:	<b>01</b> :00 - 05:00																																	
Stop Charge SOC:	50%																																	
Charge Power:	50%																																	
OK																																		
Bat First Setting																																		
AC Charge:	Disable																																	
Time Interval:	1																																	
Time Active:	Enable																																	
Time:	01:00 - <b>02</b> :00																																	
Stop Charge SOC:	50%																																	
Charge Power:	50%																																	
OK																																		
<p><b>▼</b> Press the Enter key.</p> <table border="1" data-bbox="118 834 445 1058"> <thead> <tr> <th colspan="2">Bat First Setting</th> </tr> </thead> <tbody> <tr> <td>AC Charge:</td> <td>Disable</td> </tr> <tr> <td>Time Interval:</td> <td>1</td> </tr> <tr> <td>Time Active:</td> <td>Enable</td> </tr> <tr> <td>Time:</td> <td>01:00 - 05:00</td> </tr> <tr> <td>Stop Charge SOC:</td> <td><b>50%</b></td> </tr> <tr> <td>Charge Power:</td> <td>50%</td> </tr> <tr> <td colspan="2">OK</td> </tr> </tbody> </table>	Bat First Setting		AC Charge:	Disable	Time Interval:	1	Time Active:	Enable	Time:	01:00 - 05:00	Stop Charge SOC:	<b>50%</b>	Charge Power:	50%	OK		<p style="text-align: center;"><b>→</b></p> <p>Press the Up or Down key to increase or reduce the Stop Charge SOC value.</p>	<table border="1" data-bbox="654 834 997 1058"> <thead> <tr> <th colspan="2">Bat First Setting</th> </tr> </thead> <tbody> <tr> <td>AC Charge:</td> <td>Disable</td> </tr> <tr> <td>Time Interval:</td> <td>1</td> </tr> <tr> <td>Time Active:</td> <td>Enable</td> </tr> <tr> <td>Time:</td> <td>01:00 - 05:00</td> </tr> <tr> <td>Stop Charge SOC:</td> <td><b>51%</b></td> </tr> <tr> <td>Charge Power:</td> <td>50%</td> </tr> <tr> <td colspan="2">OK</td> </tr> </tbody> </table>	Bat First Setting		AC Charge:	Disable	Time Interval:	1	Time Active:	Enable	Time:	01:00 - 05:00	Stop Charge SOC:	<b>51%</b>	Charge Power:	50%	OK	
Bat First Setting																																		
AC Charge:	Disable																																	
Time Interval:	1																																	
Time Active:	Enable																																	
Time:	01:00 - 05:00																																	
Stop Charge SOC:	<b>50%</b>																																	
Charge Power:	50%																																	
OK																																		
Bat First Setting																																		
AC Charge:	Disable																																	
Time Interval:	1																																	
Time Active:	Enable																																	
Time:	01:00 - 05:00																																	
Stop Charge SOC:	<b>51%</b>																																	
Charge Power:	50%																																	
OK																																		
<p><b>▼</b> Press the Enter key.</p> <table border="1" data-bbox="118 1181 445 1404"> <thead> <tr> <th colspan="2">Bat First Setting</th> </tr> </thead> <tbody> <tr> <td>AC Charge:</td> <td>Disable</td> </tr> <tr> <td>Time Interval:</td> <td>1</td> </tr> <tr> <td>Time Active:</td> <td>Enable</td> </tr> <tr> <td>Time:</td> <td>01:00 - 05:00</td> </tr> <tr> <td>Stop Charge SOC:</td> <td>50%</td> </tr> <tr> <td>Charge Power:</td> <td><b>50%</b></td> </tr> <tr> <td colspan="2">OK</td> </tr> </tbody> </table>	Bat First Setting		AC Charge:	Disable	Time Interval:	1	Time Active:	Enable	Time:	01:00 - 05:00	Stop Charge SOC:	50%	Charge Power:	<b>50%</b>	OK		<p style="text-align: center;"><b>→</b></p> <p>Press the Up or Down key to increase or reduce the Charge Power value.</p>	<table border="1" data-bbox="654 1181 997 1404"> <thead> <tr> <th colspan="2">Bat First Setting</th> </tr> </thead> <tbody> <tr> <td>AC Charge:</td> <td>Disable</td> </tr> <tr> <td>Time Interval:</td> <td>1</td> </tr> <tr> <td>Time Active:</td> <td>Enable</td> </tr> <tr> <td>Time:</td> <td>01:00 - 05:00</td> </tr> <tr> <td>Stop Charge SOC:</td> <td>50%</td> </tr> <tr> <td>Charge Power:</td> <td><b>51%</b></td> </tr> <tr> <td colspan="2">OK</td> </tr> </tbody> </table>	Bat First Setting		AC Charge:	Disable	Time Interval:	1	Time Active:	Enable	Time:	01:00 - 05:00	Stop Charge SOC:	50%	Charge Power:	<b>51%</b>	OK	
Bat First Setting																																		
AC Charge:	Disable																																	
Time Interval:	1																																	
Time Active:	Enable																																	
Time:	01:00 - 05:00																																	
Stop Charge SOC:	50%																																	
Charge Power:	<b>50%</b>																																	
OK																																		
Bat First Setting																																		
AC Charge:	Disable																																	
Time Interval:	1																																	
Time Active:	Enable																																	
Time:	01:00 - 05:00																																	
Stop Charge SOC:	50%																																	
Charge Power:	<b>51%</b>																																	
OK																																		

<p>▼ Press the Enter key.</p>																																		
<table border="1"> <tr><th colspan="2">Bat First Setting</th></tr> <tr><td>AC Charge:</td><td>Disable</td></tr> <tr><td>Time Interval:</td><td>1</td></tr> <tr><td>Time Active:</td><td>Enable</td></tr> <tr><td>Time:</td><td>01:00 - 05:00</td></tr> <tr><td>Stop Charge SOC:</td><td>50%</td></tr> <tr><td>Charge Power:</td><td>50%</td></tr> <tr><td colspan="2" style="text-align: center;">OK</td></tr> </table>	Bat First Setting		AC Charge:	Disable	Time Interval:	1	Time Active:	Enable	Time:	01:00 - 05:00	Stop Charge SOC:	50%	Charge Power:	50%	OK		<p>→</p> <p>Press the Enter key.</p>	<table border="1"> <tr><th colspan="2">Bat First Setting</th></tr> <tr><td>AC Charge:</td><td>Disable</td></tr> <tr><td>Time Interval:</td><td>1</td></tr> <tr><td>Time Active:</td><td>Enable</td></tr> <tr><td>Time:</td><td>01:00 - 05:00</td></tr> <tr><td>Stop Charge SOC:</td><td>50%</td></tr> <tr><td>Charge Power:</td><td>50%</td></tr> <tr><td colspan="2" style="text-align: center;">Setting...</td></tr> </table>	Bat First Setting		AC Charge:	Disable	Time Interval:	1	Time Active:	Enable	Time:	01:00 - 05:00	Stop Charge SOC:	50%	Charge Power:	50%	Setting...	
Bat First Setting																																		
AC Charge:	Disable																																	
Time Interval:	1																																	
Time Active:	Enable																																	
Time:	01:00 - 05:00																																	
Stop Charge SOC:	50%																																	
Charge Power:	50%																																	
OK																																		
Bat First Setting																																		
AC Charge:	Disable																																	
Time Interval:	1																																	
Time Active:	Enable																																	
Time:	01:00 - 05:00																																	
Stop Charge SOC:	50%																																	
Charge Power:	50%																																	
Setting...																																		
		<p>▼ Wait for 3 seconds.</p>																																
		<table border="1"> <tr><th colspan="2">Bat First Setting</th></tr> <tr><td>AC Charge:</td><td>Disable</td></tr> <tr><td>Time Interval:</td><td>1</td></tr> <tr><td>Time Active:</td><td>Enable</td></tr> <tr><td>Time:</td><td>01:00 - 05:00</td></tr> <tr><td>Stop Charge SOC:</td><td>50%</td></tr> <tr><td>Charge Power:</td><td>50%</td></tr> <tr><td colspan="2" style="text-align: center;">Setting Ok!</td></tr> </table>	Bat First Setting		AC Charge:	Disable	Time Interval:	1	Time Active:	Enable	Time:	01:00 - 05:00	Stop Charge SOC:	50%	Charge Power:	50%	Setting Ok!																	
Bat First Setting																																		
AC Charge:	Disable																																	
Time Interval:	1																																	
Time Active:	Enable																																	
Time:	01:00 - 05:00																																	
Stop Charge SOC:	50%																																	
Charge Power:	50%																																	
Setting Ok!																																		

Set Grid First mode in the following steps.

<table border="1"> <tr><th colspan="2">Priority Setting</th></tr> <tr><td>1. Bat First Setting</td><td></td></tr> <tr><td>2. Grid First Setting</td><td></td></tr> </table>	Priority Setting		1. Bat First Setting		2. Grid First Setting		<p>→</p> <p>Press the Enter key.</p>	<table border="1"> <tr><th colspan="2">Grid First Setting</th></tr> <tr><td>Time Interval:</td><td>1</td></tr> <tr><td>Time Active:</td><td>Enable</td></tr> <tr><td>Time:</td><td>01:00 - 05:00</td></tr> <tr><td>Stop Discharge SOC:</td><td>50%</td></tr> <tr><td>Discharge Power:</td><td>50%</td></tr> <tr><td colspan="2" style="text-align: center;">OK</td></tr> </table>	Grid First Setting		Time Interval:	1	Time Active:	Enable	Time:	01:00 - 05:00	Stop Discharge SOC:	50%	Discharge Power:	50%	OK									
Priority Setting																														
1. Bat First Setting																														
2. Grid First Setting																														
Grid First Setting																														
Time Interval:	1																													
Time Active:	Enable																													
Time:	01:00 - 05:00																													
Stop Discharge SOC:	50%																													
Discharge Power:	50%																													
OK																														
<p>▼ Press the Enter key.</p>																														
<table border="1"> <tr><th colspan="2">Grid First Setting</th></tr> <tr><td>Time Interval:</td><td>1</td></tr> <tr><td>Time Active:</td><td>Enable</td></tr> <tr><td>Time:</td><td>01:00 - 05:00</td></tr> <tr><td>Stop Discharge SOC:</td><td>50%</td></tr> <tr><td>Discharge Power:</td><td>50%</td></tr> <tr><td colspan="2" style="text-align: center;">OK</td></tr> </table>	Grid First Setting		Time Interval:	1	Time Active:	Enable	Time:	01:00 - 05:00	Stop Discharge SOC:	50%	Discharge Power:	50%	OK		<p>→</p> <p>Press the Up or Down key to select a time interval.</p>	<table border="1"> <tr><th colspan="2">Grid First Setting</th></tr> <tr><td>Time Interval:</td><td>2</td></tr> <tr><td>Time Active:</td><td>Enable</td></tr> <tr><td>Time:</td><td>01:00 - 05:00</td></tr> <tr><td>Stop Discharge SOC:</td><td>50%</td></tr> <tr><td>Discharge Power:</td><td>50%</td></tr> <tr><td colspan="2" style="text-align: center;">OK</td></tr> </table>	Grid First Setting		Time Interval:	2	Time Active:	Enable	Time:	01:00 - 05:00	Stop Discharge SOC:	50%	Discharge Power:	50%	OK	
Grid First Setting																														
Time Interval:	1																													
Time Active:	Enable																													
Time:	01:00 - 05:00																													
Stop Discharge SOC:	50%																													
Discharge Power:	50%																													
OK																														
Grid First Setting																														
Time Interval:	2																													
Time Active:	Enable																													
Time:	01:00 - 05:00																													
Stop Discharge SOC:	50%																													
Discharge Power:	50%																													
OK																														
<p>▼ Press the Enter key.</p>																														

<table border="1"> <tr><th colspan="2">Grid First Setting</th></tr> <tr><td>Time Interval:</td><td>1</td></tr> <tr><td>Time Active:</td><td>Enable</td></tr> <tr><td>Time:</td><td>01:00 - 05:00</td></tr> <tr><td>Stop Discharge SOC:</td><td>50%</td></tr> <tr><td>Discharge Power:</td><td>50%</td></tr> <tr><td colspan="2">OK</td></tr> </table>	Grid First Setting		Time Interval:	1	Time Active:	Enable	Time:	01:00 - 05:00	Stop Discharge SOC:	50%	Discharge Power:	50%	OK		<p style="text-align: center;">→</p> <p>Press the Up or Down key to enable or disable the active time period.</p>	<table border="1"> <tr><th colspan="2">Grid First Setting</th></tr> <tr><td>Time Interval:</td><td>1</td></tr> <tr><td>Time Active:</td><td>Disable</td></tr> <tr><td>Time:</td><td>01:00 - 05:00</td></tr> <tr><td>Stop Discharge SOC:</td><td>50%</td></tr> <tr><td>Discharge Power:</td><td>50%</td></tr> <tr><td colspan="2">OK</td></tr> </table>	Grid First Setting		Time Interval:	1	Time Active:	Disable	Time:	01:00 - 05:00	Stop Discharge SOC:	50%	Discharge Power:	50%	OK	
Grid First Setting																														
Time Interval:	1																													
Time Active:	Enable																													
Time:	01:00 - 05:00																													
Stop Discharge SOC:	50%																													
Discharge Power:	50%																													
OK																														
Grid First Setting																														
Time Interval:	1																													
Time Active:	Disable																													
Time:	01:00 - 05:00																													
Stop Discharge SOC:	50%																													
Discharge Power:	50%																													
OK																														
<p>▼ Press the Enter key.</p>																														
<table border="1"> <tr><th colspan="2">Grid First Setting</th></tr> <tr><td>Time Interval:</td><td>1</td></tr> <tr><td>Time Active:</td><td>Disable</td></tr> <tr><td>Time:</td><td>01:00 - 05:00</td></tr> <tr><td>Stop Discharge SOC:</td><td>50%</td></tr> <tr><td>Discharge Power:</td><td>50%</td></tr> <tr><td colspan="2">OK</td></tr> </table>	Grid First Setting		Time Interval:	1	Time Active:	Disable	Time:	01:00 - 05:00	Stop Discharge SOC:	50%	Discharge Power:	50%	OK		<p style="text-align: center;">→</p> <p>Press the Up or Down key to increase or reduce the time duration.</p>	<table border="1"> <tr><th colspan="2">Grid First Setting</th></tr> <tr><td>Time Interval:</td><td>1</td></tr> <tr><td>Time Active:</td><td>Disable</td></tr> <tr><td>Time:</td><td>02:00 - 05:00</td></tr> <tr><td>Stop Discharge SOC:</td><td>50%</td></tr> <tr><td>Discharge Power:</td><td>50%</td></tr> <tr><td colspan="2">OK</td></tr> </table>	Grid First Setting		Time Interval:	1	Time Active:	Disable	Time:	02:00 - 05:00	Stop Discharge SOC:	50%	Discharge Power:	50%	OK	
Grid First Setting																														
Time Interval:	1																													
Time Active:	Disable																													
Time:	01:00 - 05:00																													
Stop Discharge SOC:	50%																													
Discharge Power:	50%																													
OK																														
Grid First Setting																														
Time Interval:	1																													
Time Active:	Disable																													
Time:	02:00 - 05:00																													
Stop Discharge SOC:	50%																													
Discharge Power:	50%																													
OK																														
<p>▼ Press the Enter key.</p>																														
<table border="1"> <tr><th colspan="2">Grid First Setting</th></tr> <tr><td>Time Interval:</td><td>1</td></tr> <tr><td>Time Active:</td><td>Disable</td></tr> <tr><td>Time:</td><td>01:00 - 05:00</td></tr> <tr><td>Stop Discharge SOC:</td><td>50%</td></tr> <tr><td>Discharge Power:</td><td>50%</td></tr> <tr><td colspan="2">OK</td></tr> </table>	Grid First Setting		Time Interval:	1	Time Active:	Disable	Time:	01:00 - 05:00	Stop Discharge SOC:	50%	Discharge Power:	50%	OK		<p style="text-align: center;">→</p> <p>Press the Up or Down key to increase or reduce the Stop Discharge SOC value.</p>	<table border="1"> <tr><th colspan="2">Grid First Setting</th></tr> <tr><td>Time Interval:</td><td>1</td></tr> <tr><td>Time Active:</td><td>Disable</td></tr> <tr><td>Time:</td><td>01:00 - 05:00</td></tr> <tr><td>Stop Discharge SOC:</td><td>51%</td></tr> <tr><td>Discharge Power:</td><td>50%</td></tr> <tr><td colspan="2">OK</td></tr> </table>	Grid First Setting		Time Interval:	1	Time Active:	Disable	Time:	01:00 - 05:00	Stop Discharge SOC:	51%	Discharge Power:	50%	OK	
Grid First Setting																														
Time Interval:	1																													
Time Active:	Disable																													
Time:	01:00 - 05:00																													
Stop Discharge SOC:	50%																													
Discharge Power:	50%																													
OK																														
Grid First Setting																														
Time Interval:	1																													
Time Active:	Disable																													
Time:	01:00 - 05:00																													
Stop Discharge SOC:	51%																													
Discharge Power:	50%																													
OK																														
<p>▼ Press the Enter key.</p>																														
<table border="1"> <tr><th colspan="2">Grid First Setting</th></tr> <tr><td>Time Interval:</td><td>1</td></tr> <tr><td>Time Active:</td><td>Disable</td></tr> <tr><td>Time:</td><td>01:00 - 05:00</td></tr> <tr><td>Stop Discharge SOC:</td><td>50%</td></tr> <tr><td>Discharge Power:</td><td>50%</td></tr> <tr><td colspan="2">OK</td></tr> </table>	Grid First Setting		Time Interval:	1	Time Active:	Disable	Time:	01:00 - 05:00	Stop Discharge SOC:	50%	Discharge Power:	50%	OK		<p style="text-align: center;">→</p> <p>Press the Up or Down key to increase or reduce the Discharge Power value.</p>	<table border="1"> <tr><th colspan="2">Grid First Setting</th></tr> <tr><td>Time Interval:</td><td>1</td></tr> <tr><td>Time Active:</td><td>Disable</td></tr> <tr><td>Time:</td><td>01:00 - 05:00</td></tr> <tr><td>Stop Discharge SOC:</td><td>50%</td></tr> <tr><td>Discharge Power:</td><td>51%</td></tr> <tr><td colspan="2">OK</td></tr> </table>	Grid First Setting		Time Interval:	1	Time Active:	Disable	Time:	01:00 - 05:00	Stop Discharge SOC:	50%	Discharge Power:	51%	OK	
Grid First Setting																														
Time Interval:	1																													
Time Active:	Disable																													
Time:	01:00 - 05:00																													
Stop Discharge SOC:	50%																													
Discharge Power:	50%																													
OK																														
Grid First Setting																														
Time Interval:	1																													
Time Active:	Disable																													
Time:	01:00 - 05:00																													
Stop Discharge SOC:	50%																													
Discharge Power:	51%																													
OK																														

<b>▼ Press the Enter key.</b>																														
<table border="1" style="width: 100%; border-collapse: collapse;"> <tr><th colspan="2" style="text-align: center;">Grid First Setting</th></tr> <tr><td>Time Interval:</td><td style="text-align: right;">1</td></tr> <tr><td>Time Active:</td><td style="text-align: right;">Disable</td></tr> <tr><td>Time:</td><td style="text-align: right;">01:00 - 05:00</td></tr> <tr><td>Stop Discharge SOC:</td><td style="text-align: right;">50%</td></tr> <tr><td>Discharge Power:</td><td style="text-align: right;">50%</td></tr> <tr><td colspan="2" style="text-align: center;"><b>OK</b></td></tr> </table>	Grid First Setting		Time Interval:	1	Time Active:	Disable	Time:	01:00 - 05:00	Stop Discharge SOC:	50%	Discharge Power:	50%	<b>OK</b>		 Press the Enter key.	<table border="1" style="width: 100%; border-collapse: collapse;"> <tr><th colspan="2" style="text-align: center;">Grid First Setting</th></tr> <tr><td>Time Interval:</td><td style="text-align: right;">1</td></tr> <tr><td>Time Active:</td><td style="text-align: right;">Disable</td></tr> <tr><td>Time:</td><td style="text-align: right;">01:00 - 05:00</td></tr> <tr><td>Stop Discharge SOC:</td><td style="text-align: right;">50%</td></tr> <tr><td>Discharge Power:</td><td style="text-align: right;">50%</td></tr> <tr><td colspan="2" style="text-align: center;"><b>Setting...</b></td></tr> </table>	Grid First Setting		Time Interval:	1	Time Active:	Disable	Time:	01:00 - 05:00	Stop Discharge SOC:	50%	Discharge Power:	50%	<b>Setting...</b>	
Grid First Setting																														
Time Interval:	1																													
Time Active:	Disable																													
Time:	01:00 - 05:00																													
Stop Discharge SOC:	50%																													
Discharge Power:	50%																													
<b>OK</b>																														
Grid First Setting																														
Time Interval:	1																													
Time Active:	Disable																													
Time:	01:00 - 05:00																													
Stop Discharge SOC:	50%																													
Discharge Power:	50%																													
<b>Setting...</b>																														
<b>▼ Wait for 3 seconds.</b>																														
<table border="1" style="width: 100%; border-collapse: collapse;"> <tr><th colspan="2" style="text-align: center;">Grid First Setting</th></tr> <tr><td>Time Interval:</td><td style="text-align: right;">1</td></tr> <tr><td>Time Active:</td><td style="text-align: right;">Disable</td></tr> <tr><td>Time:</td><td style="text-align: right;">01:00 - 05:00</td></tr> <tr><td>Stop Discharge SOC:</td><td style="text-align: right;">50%</td></tr> <tr><td>Discharge Power:</td><td style="text-align: right;">50%</td></tr> <tr><td colspan="2" style="text-align: center;"><b>Setting Ok!</b></td></tr> </table>	Grid First Setting		Time Interval:	1	Time Active:	Disable	Time:	01:00 - 05:00	Stop Discharge SOC:	50%	Discharge Power:	50%	<b>Setting Ok!</b>																	
Grid First Setting																														
Time Interval:	1																													
Time Active:	Disable																													
Time:	01:00 - 05:00																													
Stop Discharge SOC:	50%																													
Discharge Power:	50%																													
<b>Setting Ok!</b>																														

**7.2.9 Auto Test Setting**

The auto test function will be available only if you select “Italy” on the Country Setting page. If you select any other country, the Auto Test Setting page will indicate “Not Support!”

<table border="1" style="width: 100%; border-collapse: collapse;"> <tr><th colspan="2" style="text-align: center;">Setting Info</th></tr> <tr><td>1.Date &amp; Time Setting</td></tr> <tr><td>2.COM Address Setting</td></tr> <tr><td>3.Language Setting</td></tr> <tr><td>4.BAT &amp; Meter Setting</td></tr> <tr><td>5.Country Setting</td></tr> <tr><td>6.Off Grid Setting</td></tr> <tr><td>7.Priority Setting</td></tr> <tr style="background-color: #e0e0e0;"><td>8.Auto Test Setting</td></tr> <tr><td>9.Restore Factory Setting</td></tr> </table>	Setting Info		1.Date & Time Setting	2.COM Address Setting	3.Language Setting	4.BAT & Meter Setting	5.Country Setting	6.Off Grid Setting	7.Priority Setting	8.Auto Test Setting	9.Restore Factory Setting	 Press the Enter key.	<table border="1" style="width: 100%; border-collapse: collapse;"> <tr><th colspan="2" style="text-align: center;">AutoTest Setting</th></tr> <tr><td colspan="2" style="text-align: center;">Not Support!</td></tr> </table>	AutoTest Setting		Not Support!	
Setting Info																	
1.Date & Time Setting																	
2.COM Address Setting																	
3.Language Setting																	
4.BAT & Meter Setting																	
5.Country Setting																	
6.Off Grid Setting																	
7.Priority Setting																	
8.Auto Test Setting																	
9.Restore Factory Setting																	
AutoTest Setting																	
Not Support!																	

If “Italy” is selected, the Auto Test Setting page is shown below.

<table border="1" style="width: 100%; border-collapse: collapse;"> <tr><th colspan="2" style="text-align: center;">Setting Info</th></tr> <tr><td>1.Date &amp; Time Setting</td></tr> <tr><td>2.COM Address Setting</td></tr> <tr><td>3.Language Setting</td></tr> <tr><td>4.BAT &amp; Meter Setting</td></tr> <tr><td>5.Country Setting</td></tr> <tr><td>6.Off Grid Setting</td></tr> <tr><td>7.Priority Setting</td></tr> <tr style="background-color: #e0e0e0;"><td>8.Auto Test Setting</td></tr> <tr><td>9.Restore Factory Setting</td></tr> </table>	Setting Info		1.Date & Time Setting	2.COM Address Setting	3.Language Setting	4.BAT & Meter Setting	5.Country Setting	6.Off Grid Setting	7.Priority Setting	8.Auto Test Setting	9.Restore Factory Setting	 Press the Enter key.	<table border="1" style="width: 100%; border-collapse: collapse;"> <tr><th colspan="2" style="text-align: center;">AutoTest Setting</th></tr> <tr><td>59. S1:</td><td style="text-align: right;">450. 3V 1000ms</td></tr> <tr><td>27. S1:</td><td style="text-align: right;">340. 5V 1000ms</td></tr> <tr><td>81&gt;. S1:</td><td style="text-align: right;">59. 15Hz 100ms</td></tr> <tr><td>81&lt;. S1:</td><td style="text-align: right;">49. 80Hz 100ms</td></tr> <tr><td>59. S2:</td><td style="text-align: right;">450. 3V 1000ms</td></tr> <tr><td>27. S2:</td><td style="text-align: right;">340. 5V 1000ms</td></tr> <tr><td>81&gt;. S2:</td><td style="text-align: right;">59. 15Hz 100ms</td></tr> <tr><td>81&lt;. S2:</td><td style="text-align: right;">49. 80Hz 100ms</td></tr> <tr><td colspan="2" style="text-align: center;"><b>AutoTest Start</b></td></tr> </table>	AutoTest Setting		59. S1:	450. 3V 1000ms	27. S1:	340. 5V 1000ms	81>. S1:	59. 15Hz 100ms	81<. S1:	49. 80Hz 100ms	59. S2:	450. 3V 1000ms	27. S2:	340. 5V 1000ms	81>. S2:	59. 15Hz 100ms	81<. S2:	49. 80Hz 100ms	<b>AutoTest Start</b>	
Setting Info																																	
1.Date & Time Setting																																	
2.COM Address Setting																																	
3.Language Setting																																	
4.BAT & Meter Setting																																	
5.Country Setting																																	
6.Off Grid Setting																																	
7.Priority Setting																																	
8.Auto Test Setting																																	
9.Restore Factory Setting																																	
AutoTest Setting																																	
59. S1:	450. 3V 1000ms																																
27. S1:	340. 5V 1000ms																																
81>. S1:	59. 15Hz 100ms																																
81<. S1:	49. 80Hz 100ms																																
59. S2:	450. 3V 1000ms																																
27. S2:	340. 5V 1000ms																																
81>. S2:	59. 15Hz 100ms																																
81<. S2:	49. 80Hz 100ms																																
<b>AutoTest Start</b>																																	

The Real value will vary with time once you start the auto test.

<table border="1" style="width: 100%; border-collapse: collapse;"> <thead> <tr> <th colspan="2" style="text-align: center;">AutoTest Setting</th> </tr> </thead> <tbody> <tr> <td>59.S1:</td> <td>450.3V 1000ms</td> </tr> <tr> <td>27.S1:</td> <td>340.5V 1000ms</td> </tr> <tr> <td>81&gt;.S1:</td> <td>59.15Hz 100ms</td> </tr> <tr> <td>81&lt;.S1:</td> <td>49.80Hz 100ms</td> </tr> <tr> <td>59.S2:</td> <td>450.3V 1000ms</td> </tr> <tr> <td>27.S2:</td> <td>340.5V 1000ms</td> </tr> <tr> <td>81&gt;.S2:</td> <td>59.15Hz 100ms</td> </tr> <tr> <td>81&lt;.S2:</td> <td>49.80Hz 100ms</td> </tr> </tbody> </table> <p style="text-align: center; margin-top: 5px;"><b>AutoTest Start</b></p>	AutoTest Setting		59.S1:	450.3V 1000ms	27.S1:	340.5V 1000ms	81>.S1:	59.15Hz 100ms	81<.S1:	49.80Hz 100ms	59.S2:	450.3V 1000ms	27.S2:	340.5V 1000ms	81>.S2:	59.15Hz 100ms	81<.S2:	49.80Hz 100ms	 Press the Enter key.	<table border="1" style="width: 100%; border-collapse: collapse;"> <thead> <tr> <th colspan="2" style="text-align: center;">AutoTest Setting</th> </tr> </thead> <tbody> <tr> <td colspan="2">Auto Testing ...</td> </tr> <tr> <td>Step:</td> <td>59.S1</td> </tr> <tr> <td>Limit:</td> <td>450.3V 1000ms</td> </tr> <tr> <td>Real:</td> <td>400.5V</td> </tr> </tbody> </table>	AutoTest Setting		Auto Testing ...		Step:	59.S1	Limit:	450.3V 1000ms	Real:	400.5V
AutoTest Setting																														
59.S1:	450.3V 1000ms																													
27.S1:	340.5V 1000ms																													
81>.S1:	59.15Hz 100ms																													
81<.S1:	49.80Hz 100ms																													
59.S2:	450.3V 1000ms																													
27.S2:	340.5V 1000ms																													
81>.S2:	59.15Hz 100ms																													
81<.S2:	49.80Hz 100ms																													
AutoTest Setting																														
Auto Testing ...																														
Step:	59.S1																													
Limit:	450.3V 1000ms																													
Real:	400.5V																													

When an item has been tested, you can see its trigger limit and test result.

<table border="1" style="width: 100%; border-collapse: collapse;"> <thead> <tr> <th colspan="2" style="text-align: center;">AutoTest Setting</th> </tr> </thead> <tbody> <tr> <td colspan="2">Auto Testing ...</td> </tr> <tr> <td>Step:</td> <td>59.S1</td> </tr> <tr> <td>Limit:</td> <td>450.3V 1000ms</td> </tr> <tr> <td>Real:</td> <td>400.5V</td> </tr> </tbody> </table>	AutoTest Setting		Auto Testing ...		Step:	59.S1	Limit:	450.3V 1000ms	Real:	400.5V	 The information is updated automatically.	<table border="1" style="width: 100%; border-collapse: collapse;"> <thead> <tr> <th colspan="2" style="text-align: center;">AutoTest Setting</th> </tr> </thead> <tbody> <tr> <td colspan="2">Auto Testing...</td> </tr> <tr> <td>Step:</td> <td>59.S1</td> </tr> <tr> <td>Limit:</td> <td>450.3V 1000ms</td> </tr> <tr> <td>Trip:</td> <td>450.5V 1000ms</td> </tr> <tr> <td>Result:</td> <td>Pass</td> </tr> </tbody> </table>	AutoTest Setting		Auto Testing...		Step:	59.S1	Limit:	450.3V 1000ms	Trip:	450.5V 1000ms	Result:	Pass
AutoTest Setting																								
Auto Testing ...																								
Step:	59.S1																							
Limit:	450.3V 1000ms																							
Real:	400.5V																							
AutoTest Setting																								
Auto Testing...																								
Step:	59.S1																							
Limit:	450.3V 1000ms																							
Trip:	450.5V 1000ms																							
Result:	Pass																							





When all items have been tested, you can see the auto test results as well as the trigger limits of all items.



<table border="1" style="width: 100%; border-collapse: collapse;"> <thead> <tr> <th colspan="2" style="text-align: center;">AutoTest Setting</th> </tr> </thead> <tbody> <tr> <td colspan="2">AutoTesting...</td> </tr> <tr> <td>Step:</td> <td>81&lt;.S2</td> </tr> <tr> <td>Limit:</td> <td>340.3V 1000ms</td> </tr> <tr> <td>Trip:</td> <td>341.5V 1000ms</td> </tr> <tr> <td>Result:</td> <td>Pass</td> </tr> </tbody> </table>	AutoTest Setting		AutoTesting...		Step:	81<.S2	Limit:	340.3V 1000ms	Trip:	341.5V 1000ms	Result:	Pass	 The information is updated automatically.	<table border="1" style="width: 100%; border-collapse: collapse;"> <thead> <tr> <th colspan="2" style="text-align: center;">AutoTest Setting</th> </tr> </thead> <tbody> <tr> <td>Auto Test Finish</td> <td>Result: Pass</td> </tr> <tr> <td>59.S1:</td> <td>450.3V 1000ms</td> </tr> <tr> <td>27.S1:</td> <td>340.5V 1000ms</td> </tr> <tr> <td>81&gt;.S1:</td> <td>59.5Hz 100ms</td> </tr> <tr> <td>81&lt;.S1:</td> <td>49.3Hz 100ms</td> </tr> <tr> <td>59.S2:</td> <td>450.3V 1000ms</td> </tr> <tr> <td>27.S2:</td> <td>340.5V 1000ms</td> </tr> <tr> <td>81&gt;.S2:</td> <td>59.5Hz 100ms</td> </tr> <tr> <td>81&lt;.S2:</td> <td>49.3Hz 100ms</td> </tr> </tbody> </table>	AutoTest Setting		Auto Test Finish	Result: Pass	59.S1:	450.3V 1000ms	27.S1:	340.5V 1000ms	81>.S1:	59.5Hz 100ms	81<.S1:	49.3Hz 100ms	59.S2:	450.3V 1000ms	27.S2:	340.5V 1000ms	81>.S2:	59.5Hz 100ms	81<.S2:	49.3Hz 100ms
AutoTest Setting																																		
AutoTesting...																																		
Step:	81<.S2																																	
Limit:	340.3V 1000ms																																	
Trip:	341.5V 1000ms																																	
Result:	Pass																																	
AutoTest Setting																																		
Auto Test Finish	Result: Pass																																	
59.S1:	450.3V 1000ms																																	
27.S1:	340.5V 1000ms																																	
81>.S1:	59.5Hz 100ms																																	
81<.S1:	49.3Hz 100ms																																	
59.S2:	450.3V 1000ms																																	
27.S2:	340.5V 1000ms																																	
81>.S2:	59.5Hz 100ms																																	
81<.S2:	49.3Hz 100ms																																	

### 7.2.10 Restore Factory Setting

This function can restore calibration data and configuration parameters to default parameters, as well as clear energy data and historical fault data. Restore factory settings is as follows:



<table border="1" style="width: 100%; border-collapse: collapse;"> <thead> <tr> <th colspan="2" style="text-align: center;">Setting Info</th> </tr> </thead> <tbody> <tr><td>1.Date &amp; Time Setting</td><td></td></tr> <tr><td>2.COM Address Setting</td><td></td></tr> <tr><td>3.Language Setting</td><td></td></tr> <tr><td>4.BAT &amp; Meter Setting</td><td></td></tr> <tr><td>5.Country Setting</td><td></td></tr> <tr><td>6.Off Grid Setting</td><td></td></tr> <tr><td>7.Priority Setting</td><td></td></tr> <tr><td>8.AutoTest Setting</td><td></td></tr> <tr style="background-color: #e0e0e0;"><td>9.Restore Factory Setting</td><td></td></tr> </tbody> </table>	Setting Info		1.Date & Time Setting		2.COM Address Setting		3.Language Setting		4.BAT & Meter Setting		5.Country Setting		6.Off Grid Setting		7.Priority Setting		8.AutoTest Setting		9.Restore Factory Setting		 Press the Enter key.	<table border="1" style="width: 100%; border-collapse: collapse;"> <thead> <tr> <th colspan="2" style="text-align: center;">Restore Factory Setting</th> </tr> </thead> <tbody> <tr> <td>Adjust Data:</td> <td style="background-color: #e0e0e0;">Disable</td> </tr> <tr> <td>Energy:</td> <td>Disable</td> </tr> <tr> <td>Fault History:</td> <td>Disable</td> </tr> <tr> <td>Config Data:</td> <td>Disable</td> </tr> <tr> <td colspan="2" style="text-align: center; margin-top: 20px;">OK</td> </tr> </tbody> </table>	Restore Factory Setting		Adjust Data:	Disable	Energy:	Disable	Fault History:	Disable	Config Data:	Disable	OK	
Setting Info																																		
1.Date & Time Setting																																		
2.COM Address Setting																																		
3.Language Setting																																		
4.BAT & Meter Setting																																		
5.Country Setting																																		
6.Off Grid Setting																																		
7.Priority Setting																																		
8.AutoTest Setting																																		
9.Restore Factory Setting																																		
Restore Factory Setting																																		
Adjust Data:	Disable																																	
Energy:	Disable																																	
Fault History:	Disable																																	
Config Data:	Disable																																	
OK																																		





<table border="1"> <thead> <tr> <th colspan="2">Restore Factory Setting</th> </tr> </thead> <tbody> <tr> <td>Adjust Data:</td> <td>Disable</td> </tr> <tr> <td>Energy:</td> <td>Disable</td> </tr> <tr> <td>Fault History:</td> <td>Disable</td> </tr> <tr> <td>Config Data:</td> <td>Disable</td> </tr> <tr> <td colspan="2" style="text-align: center;">OK</td> </tr> </tbody> </table>	Restore Factory Setting		Adjust Data:	Disable	Energy:	Disable	Fault History:	Disable	Config Data:	Disable	OK		  Press the Up or Down key to enable or disable the reset of calibration data.	<table border="1"> <thead> <tr> <th colspan="2">Restore Factory Setting</th> </tr> </thead> <tbody> <tr> <td>Adjust Data:</td> <td>Enable</td> </tr> <tr> <td>Energy:</td> <td>Disable</td> </tr> <tr> <td>Fault History:</td> <td>Disable</td> </tr> <tr> <td>Config Data:</td> <td>Disable</td> </tr> <tr> <td colspan="2" style="text-align: center;">OK</td> </tr> </tbody> </table>	Restore Factory Setting		Adjust Data:	Enable	Energy:	Disable	Fault History:	Disable	Config Data:	Disable	OK	
Restore Factory Setting																										
Adjust Data:	Disable																									
Energy:	Disable																									
Fault History:	Disable																									
Config Data:	Disable																									
OK																										
Restore Factory Setting																										
Adjust Data:	Enable																									
Energy:	Disable																									
Fault History:	Disable																									
Config Data:	Disable																									
OK																										
▼ Press the Enter key.																										
<table border="1"> <thead> <tr> <th colspan="2">Restore Factory Setting</th> </tr> </thead> <tbody> <tr> <td>Adjust Data:</td> <td>Disable</td> </tr> <tr> <td>Energy:</td> <td>Disable</td> </tr> <tr> <td>Fault History:</td> <td>Disable</td> </tr> <tr> <td>Config Data:</td> <td>Disable</td> </tr> <tr> <td colspan="2" style="text-align: center;">OK</td> </tr> </tbody> </table>	Restore Factory Setting		Adjust Data:	Disable	Energy:	Disable	Fault History:	Disable	Config Data:	Disable	OK		  Press the Up or Down key to enable or disable the clearing of energy data.	<table border="1"> <thead> <tr> <th colspan="2">Restore Factory Setting</th> </tr> </thead> <tbody> <tr> <td>Adjust Data:</td> <td>Disable</td> </tr> <tr> <td>Energy:</td> <td>Enable</td> </tr> <tr> <td>Fault History:</td> <td>Disable</td> </tr> <tr> <td>Config Data:</td> <td>Disable</td> </tr> <tr> <td colspan="2" style="text-align: center;">OK</td> </tr> </tbody> </table>	Restore Factory Setting		Adjust Data:	Disable	Energy:	Enable	Fault History:	Disable	Config Data:	Disable	OK	
Restore Factory Setting																										
Adjust Data:	Disable																									
Energy:	Disable																									
Fault History:	Disable																									
Config Data:	Disable																									
OK																										
Restore Factory Setting																										
Adjust Data:	Disable																									
Energy:	Enable																									
Fault History:	Disable																									
Config Data:	Disable																									
OK																										
▼ Press the Enter key.																										
<table border="1"> <thead> <tr> <th colspan="2">Restore Factory Setting</th> </tr> </thead> <tbody> <tr> <td>Adjust Data:</td> <td>Disable</td> </tr> <tr> <td>Energy:</td> <td>Disable</td> </tr> <tr> <td>Fault History:</td> <td>Disable</td> </tr> <tr> <td>Config Data:</td> <td>Disable</td> </tr> <tr> <td colspan="2" style="text-align: center;">OK</td> </tr> </tbody> </table>	Restore Factory Setting		Adjust Data:	Disable	Energy:	Disable	Fault History:	Disable	Config Data:	Disable	OK		  Press the Up or Down key to enable or disable the clearing of fault history.	<table border="1"> <thead> <tr> <th colspan="2">Restore Factory Setting</th> </tr> </thead> <tbody> <tr> <td>Adjust Data:</td> <td>Disable</td> </tr> <tr> <td>Energy:</td> <td>Disable</td> </tr> <tr> <td>Fault History:</td> <td>Enable</td> </tr> <tr> <td>Config Data:</td> <td>Disable</td> </tr> <tr> <td colspan="2" style="text-align: center;">OK</td> </tr> </tbody> </table>	Restore Factory Setting		Adjust Data:	Disable	Energy:	Disable	Fault History:	Enable	Config Data:	Disable	OK	
Restore Factory Setting																										
Adjust Data:	Disable																									
Energy:	Disable																									
Fault History:	Disable																									
Config Data:	Disable																									
OK																										
Restore Factory Setting																										
Adjust Data:	Disable																									
Energy:	Disable																									
Fault History:	Enable																									
Config Data:	Disable																									
OK																										
▼ Press the Enter key.																										
<table border="1"> <thead> <tr> <th colspan="2">Restore Factory Setting</th> </tr> </thead> <tbody> <tr> <td>Adjust Data:</td> <td>Disable</td> </tr> <tr> <td>Energy:</td> <td>Disable</td> </tr> <tr> <td>Fault History:</td> <td>Disable</td> </tr> <tr> <td>Config Data:</td> <td>Disable</td> </tr> <tr> <td colspan="2" style="text-align: center;">OK</td> </tr> </tbody> </table>	Restore Factory Setting		Adjust Data:	Disable	Energy:	Disable	Fault History:	Disable	Config Data:	Disable	OK		  Press the Up or Down key to enable or disable the reset of configuration data.	<table border="1"> <thead> <tr> <th colspan="2">Restore Factory Setting</th> </tr> </thead> <tbody> <tr> <td>Adjust Data:</td> <td>Disable</td> </tr> <tr> <td>Energy:</td> <td>Disable</td> </tr> <tr> <td>Fault History:</td> <td>Disable</td> </tr> <tr> <td>Config Data:</td> <td>Enable</td> </tr> <tr> <td colspan="2" style="text-align: center;">OK</td> </tr> </tbody> </table>	Restore Factory Setting		Adjust Data:	Disable	Energy:	Disable	Fault History:	Disable	Config Data:	Enable	OK	
Restore Factory Setting																										
Adjust Data:	Disable																									
Energy:	Disable																									
Fault History:	Disable																									
Config Data:	Disable																									
OK																										
Restore Factory Setting																										
Adjust Data:	Disable																									
Energy:	Disable																									
Fault History:	Disable																									
Config Data:	Enable																									
OK																										

<table border="1"> <thead> <tr> <th colspan="2">Restore Factory Setting</th> </tr> </thead> <tbody> <tr> <td>Adjust Data:</td> <td>Disable</td> </tr> <tr> <td>Energy Data:</td> <td>Disable</td> </tr> <tr> <td>Fault History:</td> <td>Disable</td> </tr> <tr> <td>Config Data:</td> <td>Disable</td> </tr> </tbody> </table> <p style="text-align: center;"><b>OK</b></p>	Restore Factory Setting		Adjust Data:	Disable	Energy Data:	Disable	Fault History:	Disable	Config Data:	Disable	 Press the Enter key.	<table border="1"> <thead> <tr> <th colspan="2">Restore Factory Setting</th> </tr> </thead> <tbody> <tr> <td>Adjust Data:</td> <td>Disable</td> </tr> <tr> <td>Energy Data:</td> <td>Disable</td> </tr> <tr> <td>Fault History:</td> <td>Disable</td> </tr> <tr> <td>Config Data:</td> <td>Disable</td> </tr> </tbody> </table> <p style="text-align: center;"><b>Setting...</b></p>	Restore Factory Setting		Adjust Data:	Disable	Energy Data:	Disable	Fault History:	Disable	Config Data:	Disable
Restore Factory Setting																						
Adjust Data:	Disable																					
Energy Data:	Disable																					
Fault History:	Disable																					
Config Data:	Disable																					
Restore Factory Setting																						
Adjust Data:	Disable																					
Energy Data:	Disable																					
Fault History:	Disable																					
Config Data:	Disable																					
		 Wait for 10 seconds.																				
		<table border="1"> <thead> <tr> <th colspan="2">Restore Factory Setting</th> </tr> </thead> <tbody> <tr> <td>Adjust Data:</td> <td>Disable</td> </tr> <tr> <td>Energy Data:</td> <td>Disable</td> </tr> <tr> <td>Fault History:</td> <td>Disable</td> </tr> <tr> <td>Config Data:</td> <td>Disable</td> </tr> </tbody> </table> <p style="text-align: center;"><b>Setting Ok!</b></p>	Restore Factory Setting		Adjust Data:	Disable	Energy Data:	Disable	Fault History:	Disable	Config Data:	Disable										
Restore Factory Setting																						
Adjust Data:	Disable																					
Energy Data:	Disable																					
Fault History:	Disable																					
Config Data:	Disable																					



### 7.2.11 Anti-Reflex Setting

Anti-Reflex Setting can set whether the anti-countercurrent meter is enabled, select the type of the meter, and limit the countercurrent power of the meter.

<table border="1"> <thead> <tr> <th colspan="2">Setting Info</th> </tr> </thead> <tbody> <tr> <td>10. Anti-Reflex Setting</td> <td></td> </tr> <tr> <td>11. Set Parallel Role</td> <td></td> </tr> </tbody> </table>	Setting Info		10. Anti-Reflex Setting		11. Set Parallel Role		 Press the Enter key. After that, Press the Up or Down key to enable or disable the meter.	<table border="1"> <thead> <tr> <th colspan="2">Meter Setting</th> </tr> </thead> <tbody> <tr> <td>Anti-Reflex:</td> <td>Disable</td> </tr> <tr> <td>Sensor:</td> <td>CT</td> </tr> <tr> <td>Power Limit</td> <td>000Kw</td> </tr> </tbody> </table> <p style="text-align: center;">OK</p>	Meter Setting		Anti-Reflex:	Disable	Sensor:	CT	Power Limit	000Kw		
Setting Info																		
10. Anti-Reflex Setting																		
11. Set Parallel Role																		
Meter Setting																		
Anti-Reflex:	Disable																	
Sensor:	CT																	
Power Limit	000Kw																	
 Press the Enter key.																		
<table border="1"> <thead> <tr> <th colspan="2">Meter Setting</th> </tr> </thead> <tbody> <tr> <td>Anti-Reflex:</td> <td>Disable</td> </tr> <tr> <td>Sensor:</td> <td>CT</td> </tr> <tr> <td>Power Limit</td> <td>000Kw</td> </tr> </tbody> </table> <p style="text-align: center;">OK</p>	Meter Setting		Anti-Reflex:	Disable	Sensor:	CT	Power Limit	000Kw	 Press Up or Down to select the type and brand of meter.	<table border="1"> <thead> <tr> <th colspan="2">Meter Setting</th> </tr> </thead> <tbody> <tr> <td>Anti-Reflex:</td> <td>Disable</td> </tr> <tr> <td>Sensor:</td> <td>GHINTT Meter</td> </tr> <tr> <td>Power Limit</td> <td>000Kw</td> </tr> </tbody> </table> <p style="text-align: center;">OK</p>	Meter Setting		Anti-Reflex:	Disable	Sensor:	GHINTT Meter	Power Limit	000Kw
Meter Setting																		
Anti-Reflex:	Disable																	
Sensor:	CT																	
Power Limit	000Kw																	
Meter Setting																		
Anti-Reflex:	Disable																	
Sensor:	GHINTT Meter																	
Power Limit	000Kw																	

 Press the Enter key.																						
<table border="1" style="width: 100%;"> <tr><th colspan="2">Meter Setting</th></tr> <tr><td>Anti-Reflex:</td><td>Disable</td></tr> <tr><td>Sensor:</td><td>CT</td></tr> <tr style="background-color: black; color: white;"><td>Power Limit</td><td>000Kw</td></tr> <tr><td colspan="2" style="text-align: center;">OK</td></tr> </table>	Meter Setting		Anti-Reflex:	Disable	Sensor:	CT	Power Limit	000Kw	OK		 Limit buy/sell electric power according to UP and Down,	<table border="1" style="width: 100%;"> <tr><th colspan="2">Meter Setting</th></tr> <tr><td>Anti-Reflex:</td><td>Disable</td></tr> <tr><td>Sensor:</td><td>CT</td></tr> <tr style="background-color: black; color: white;"><td>Power Limit</td><td>100Kw</td></tr> <tr><td colspan="2" style="text-align: center;">OK</td></tr> </table>	Meter Setting		Anti-Reflex:	Disable	Sensor:	CT	Power Limit	100Kw	OK	
Meter Setting																						
Anti-Reflex:	Disable																					
Sensor:	CT																					
Power Limit	000Kw																					
OK																						
Meter Setting																						
Anti-Reflex:	Disable																					
Sensor:	CT																					
Power Limit	100Kw																					
OK																						
 Press the Enter key.																						
<table border="1" style="width: 100%;"> <tr><th colspan="2">Meter Setting</th></tr> <tr><td>Anti-Reflex:</td><td>Disable</td></tr> <tr><td>Sensor:</td><td>CT</td></tr> <tr><td>Power Limit</td><td>100Kw</td></tr> <tr><td colspan="2" style="text-align: center;">OK</td></tr> </table>	Meter Setting		Anti-Reflex:	Disable	Sensor:	CT	Power Limit	100Kw	OK		 Press the Enter key.	<table border="1" style="width: 100%;"> <tr><th colspan="2">Meter Setting</th></tr> <tr><td>Anti-Reflex:</td><td>Disable</td></tr> <tr><td>Sensor:</td><td>CT</td></tr> <tr><td>Power Limit</td><td>100Kw</td></tr> <tr><td colspan="2" style="text-align: center;">Setting OK!</td></tr> </table>	Meter Setting		Anti-Reflex:	Disable	Sensor:	CT	Power Limit	100Kw	Setting OK!	
Meter Setting																						
Anti-Reflex:	Disable																					
Sensor:	CT																					
Power Limit	100Kw																					
OK																						
Meter Setting																						
Anti-Reflex:	Disable																					
Sensor:	CT																					
Power Limit	100Kw																					
Setting OK!																						

### 7.2.12 Set Parallel Role

<table border="1" style="width: 100%;"> <tr><th colspan="2">Setting Info</th></tr> <tr><td>10. Anti-Reflex Setting</td></tr> <tr style="background-color: black; color: white;"><td>11. Set Parallel Role</td></tr> </table>	Setting Info		10. Anti-Reflex Setting	11. Set Parallel Role	 Press the Enter key.	<table border="1" style="width: 100%;"> <tr><th colspan="2">Set Parallel Role</th></tr> <tr style="background-color: black; color: white;"><td>Role: 1 Phase Master</td></tr> <tr><td colspan="2" style="text-align: center;">OK</td></tr> </table>	Set Parallel Role		Role: 1 Phase Master	OK		
Setting Info												
10. Anti-Reflex Setting												
11. Set Parallel Role												
Set Parallel Role												
Role: 1 Phase Master												
OK												
<table border="1" style="width: 100%;"> <tr><th colspan="2">Set Parallel Role</th></tr> <tr><td>Role: 2 Slave</td></tr> <tr><td colspan="2" style="text-align: center;">OK</td></tr> </table>	Set Parallel Role		Role: 2 Slave	OK		 Press the UP or Down button to select the role. After that, Press Enter twice to set.	<table border="1" style="width: 100%;"> <tr><th colspan="2">Set Parallel Role</th></tr> <tr><td>Role: 2 Slave</td></tr> <tr><td colspan="2" style="text-align: center;">Setting Ok!/Fail!</td></tr> </table>	Set Parallel Role		Role: 2 Slave	Setting Ok!/Fail!	
Set Parallel Role												
Role: 2 Slave												
OK												
Set Parallel Role												
Role: 2 Slave												
Setting Ok!/Fail!												



## Chapter 8 System Debugging

### 8.1 LCD Screen and Keys

#### 8.1.1 LCD Screen

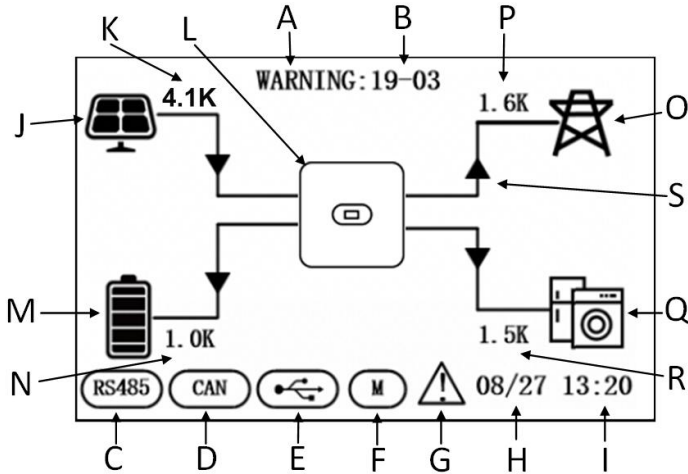

Fig. 8-1

Position	Description
A	State
B	Fault code
C	RS485 communication
D	CAN communication
E	USB
F	Smart meter
G	Fault warning
H	Date
I	Time
J	PV input
K	PV power
L	Hybrid inverter

M	Battery indicator (20% × 5 bars)
N	Battery power
O	Grid
P	Grid power
Q	Critical load
R	Load power
S	Energy flow arrow

8.1.2 LEDs, Screen and Keys

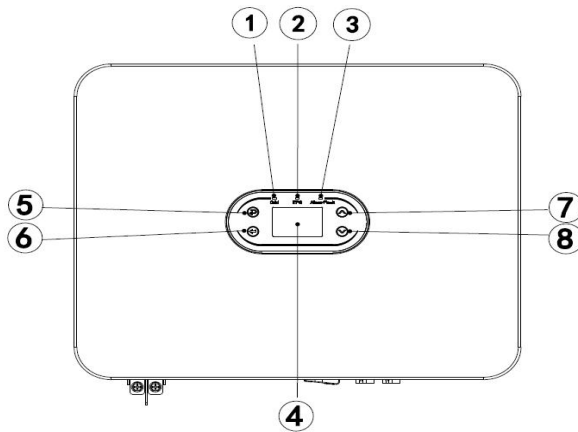

Fig. 8-2

Position	Description
1	Green LED remaining on: in the on-grid state.
	Green LED flashing: during the power-on self-test.
	Green and yellow LED flashing: during the program burning process.
2	Yellow LED remaining on: in the off-grid state.
3	Red LED remaining on: in the fault state.
4	LCD screen
5	Return key
6	Enter key
7	Up key
8	Down key

## 8.2 Working Mode

### 8.2.1 Normal Mode

In normal mode, the inverter may work in on-grid state or off-grid state.

#### On-grid State

When the hybrid inverter works in on-grid state, you can select a priority mode as needed. On the LCD screen, you can only set one period for each priority mode; while on the App, you can set up to three periods for each priority mode.

1. Load First: This is the default priority mode. When the system works in this mode, the PV energy will be provided to the load first. When the PV energy is not sufficient to meet the load need, the battery will begin to supply power. When the PV energy has fulfilled the load need, the excess power will be stored in the battery. If no battery is connected or the battery is already full, the excess power will be supplied to the grid (if anti-reflux protection is not enabled).

2. Battery First: When the system works in this mode, the battery will be charged first. To charge the battery by AC power, you need to enable the AC Charge function and set the period and battery SOC. If the AC Charge function is not enabled, the hybrid inverter will only charge the battery by PV energy. You can also set the discharge power (maximum discharge percentage of the battery). In Battery First mode, the actual discharge energy of the battery will not exceed the set percentage.

3. Grid First: When the system works in this mode, the PV energy will be supplied to the grid first. Users can export energy to the grid during peak hours, and need to set the period and battery SOC. You can also set the discharge power (maximum discharge percentage of the battery). In Grid First mode, the actual discharge energy of the battery will not exceed the set percentage.

#### Off-grid State

In case of grid power failure, the system will automatically get into the off-grid state (you can disable this function as instructed in Section 9.1).

In this state, the system will output voltage via the EPS port and power the load by the battery and solar PV panel. Please note that the load at the EPS port should not exceed the maximum output power (6000W) of the inverter.

Note:

1. In Grid First mode or Battery First mode, you can only set one period on the LCD screen. If you need to set more period, please use Solarman App.

2. To charge the battery by AC power, you need to enter your login password and then enable the AC Charge function.

### 8.2.2 Fault State

INVT hybrid inverter has an intelligent control system that can continuously monitor and adjust the state of

the system. In case of a system fault or device fault, the fault information will be displayed on the LCD screen and the corresponding LED will be turned on.

Note:

- A) See Section 10.1 for more fault information.
- B) Some of the fault information is intended to remind you of possible internal faults of the inverter.

### 8.2.3 Firmware Upgrade

Do not turn off the power during the firmware upgrade progress. The system will automatically proceed to working mode at the end of firmware upgrade.

### 8.2.4 Self-test state

Before activating the working mode, the system will get into the power-on self-test state. If no fault is detected, the system will proceed to working mode; otherwise, it will get into the fault state.

### 8.2.5 Standby State

When no fault is detected and a certain operating condition has not been met, the system will get into the standby state.

### 8.2.6 Power-off State

To stop the operation of the hybrid inverter, please disconnect all energy sources to enter automatic shutdown.

Below are the shutdown steps:

1. Step 1: Disconnect the PV side;
2. Turn off the BAT switch;
3. Disconnect the power grid. Both the LED light and LCD screen will be turned off.

Note: At the end of the above steps, please wait at least 5 minutes before proceeding to other operations.

<b>NOTE</b>
At the end of the above steps, please wait at least 5 minutes before proceeding to other operations.

## 8.3 Setting Parameters in Solarman App

Note: To ensure normal operation of the inverter, use Solarman App to set the parameters of the hybrid inverter first.

NOTE
To ensure normal operation of the inverter, please use Solarman App to set the parameters of the hybrid inverter first.

Solarman is a mobile App that can communicate with the hybrid inverter via WiFi or GPRS. It allows you to:

1. Check the running data, software version and fault information of the inverter;
2. Set the grid parameters and communication parameters of the inverter;
3. Perform maintenance of the inverter;
4. Update the software version of the inverter.

For more functions of the Solarman App, please read its User Guide, which is available on <https://www.invt.com/>.

## Chapter 9 System Maintenance

INVT hybrid inverter has undergone a series of tests before delivery. To maintain and extend the service life of the inverter, you need to perform necessary routine maintenance in addition to using it in strict accordance with this Manual.

Make sure the inverter is disconnected from the power supply.
---

To operate the inverter, please wear personal protective equipment.
---

### 9.1 Regular Maintenance of Inverter

Maintenance Item	Process	Interval
Saving the inverter's running data	Use the monitoring software to read the inverter data in real time, and back up the recorded data periodically. Save the running data, parameters and logs of the inverter recorded by the monitoring software to a file. Check the monitoring software and view the parameter settings of the inverter through the hand-held keyboard.	Every quarter
Inverter Running condition of the inverter	Observe whether the inverter is installed securely, damaged or deformed. Check if there is any abnormal sound during operation. Check the variables when the system is running in on-grid state. Check whether the heating of the inverter housing is normal, and use the thermal imager to monitor the heating of the system.	Every six months
Cleaning the inverter	Check the ambient humidity and dust around the inverter. If they affect the heat dissipation of the inverter, shut down the inverter and turn off the power supply, and clean the inverter with a soft brush or dry cloth after it cools down.	Every six months
DC switch	Check whether the DC switch functions properly by turning it on and off 10 times consecutively.	Every year
Electrical connection	Check whether the cable connections and the terminals of the inverter become loose. Check the cables for damage, especially whether there are any cuts on the cable skin that may come in contact with metal surface.	Every six months
Sealing	Check whether the sealing of the cable holes meets the requirements. If any cable hole is not sealed or shows a large sealing gap, re-seal it.	Every year
Safety function	Check the LCD screen and the system shutdown function. Simulate a shutdown and check the shutdown signal communication. Check the warning labels and replace them if necessary.	Every year

## 9.2 Powering Off the Inverter

**DANGER**

- To perform maintenance of the inverter, please power off the inverter so as to avoid damage to the inverter and avoid the risk of electric shock.
- When the inverter is powered off, it will take time for the internal components to discharge. Please wait for the time period specified on the label until the inverter is fully discharged.

Step 1: Disconnect the on-grid AC circuit breaker of the inverter.

Step 2: Disconnect the back-up AC circuit breaker of the inverter.

Step 3: Disconnect the EPS circuit breaker between the inverter and battery.

## 9.3 Removing the Inverter

Step 1: Disconnect all electrical connections of the inverter, including the DC wire, AC wire, communication cable, communication module and grounding wire.

Step 2: Remove the inverter from the mounting bracket.

Step 3: Remove the mounting bracket.

Step 4: Keep the inverter properly for future use, according to the storage environment requirements.

## 9.4 Scrapping the Inverter

If the inverter cannot be used any longer, dispose of the inverter according to the electrical waste disposal requirements of the laws and regulations of your country/region. Do not dispose of the inverter as household waste.

## Chapter 10 Troubleshooting

### Fault Codes and Troubleshooting



#### WARNING

If you are not professional at troubleshooting, contact your dealer for help. Please wear personal protective equipment and power off the inverter before troubleshooting!

This Chapter lists the faults by a list of fault codes, so that you can find troubleshooting actions quickly.

You can use the following methods to do troubleshooting. If they cannot help you, contact our After-sales Service Center.

Please provide the following information to our After-sales Service Center so that we can help you more quickly.

- Model No. of the inverter: \_\_\_\_\_;
  - SN of the inverter: \_\_\_\_\_;
  - System version of the inverter — version 1: \_\_\_\_\_;  
— Version 2: \_\_\_\_\_;  
— MCU software version: \_\_\_\_\_;
  - Fault code: \_\_\_\_\_;
  - Installation environment of the inverter: \_\_\_\_\_;
- Description of fault: \_\_\_\_\_.



Table 10-1 Fault Codes of Inverter

No.	Fault Type	Fault Code	Fault Description	Actions
1	PV voltage error	01-01	Low PV voltage	Check whether the PV panel is connected properly, damaged, covered with dust, or blocked by any objects.
		01-02	High PV voltage	Check whether the PV panel is connected properly, and whether the PV voltage is higher than the maximum working voltage of the inverter.
		01-03	Short circuit of PV panel	Check whether the PV panel is short-circuited.
2	BUS voltage error	03-01	Low BUS voltage	This fault usually occurs in the early morning. Please check the cleanliness of the PV panel surface.
		03-02	High BUS voltage	Check whether the PV panel is connected properly, and whether the PV voltage is higher than the maximum working voltage of the inverter.
		03-04	Over-voltage of hardware Bus	Restart the inverter. If the fault still exists, contact your dealer.
3	Over-current	05-01	Over-current of inverter hardware	Restart the inverter. If the fault still exists, contact your dealer.
		05-02	Over-current of inverter software	
		05-03	Over-current of boost hardware	
		05-04	Over-current of boost software	
		05-05	Auxiliary power hardware TZ failure	
		05-06	Over-voltage of Bus hardware TZ	
		05-07	Hardware TZ failure at LLC side	
		05-08	Over-current of buck-boost software	
4	Temperature error	06-01	Abnormal inverter temperature	Check the inverter temperature. If the temperature is too high, cool the inverter down before use.
		06-02	Abnormal Boost temperature	
		06-03	Abnormal radiator	

No.	Fault Type	Fault Code	Fault Description	Actions
			temperature	
		06-04	Abnormal ambient temperature	
		06-05	Abnormal buck-boost temperature	
		06-06	Open circuit of NTC thermistor	
5	Insulation monitoring error	07-01	Insulation monitoring error	Check whether the inverter and PV panel are grounded reliably. Power off the inverter for 5 minutes and then power it on again. If the fault still exists, contact your dealer.
6	Driver error	08-01	Driver error	Restart the inverter. If the fault still exists, contact your dealer.
7	Communication error	09-01	Communication error from ARM to master DSP	Restart the inverter. If the fault still exists, contact your dealer.
		09-02	Communication error from master DSP to ARM	
		09-03	Communication error from ARM to slave DSP	
		09-04	Communication error from slave DSP to ARM	
		09-05	Communication error between master and slave chips - master chip failure	Restart the inverter. If the fault still exists, contact your dealer.
		09-06	Communication error between master and slave chips - slave chip failure	Restart the inverter. If the fault still exists, contact your dealer.
		09-07	Communication error between DSP and AFCI	Restart the inverter. If the fault still exists, contact your dealer.
8	Leakage current error	10-01	High static leakage current	1. If the fault occurs occasionally, it may be caused by accidental abnormality of external cables. You can restart the inverter to resume normal operation. 2. If the fault occurs frequently or lasts long, check whether the PV string is grounded reliably.
		10-02	Abrupt fault of 30mA	
		10-03	Abrupt fault of 60mA	
		10-04	Abrupt fault of 150mA	
9	Relay failure	11-01	Open circuit of relay	Restart the inverter. If the fault still exists, contact your dealer.
		11-02	Short circuit of relay	

No.	Fault Type	Fault Code	Fault Description	Actions
10	Internal fan failure	12-01	Internal fan failure	Restart the inverter. If the fault still exists, contact your dealer.
11	DCI error	14-01	DCI error of R-phase	Check whether the inverter and PV panel are grounded reliably. Power off the inverter for 5 minutes and then power it on again. If the fault still exists, contact your dealer.
12	Consistency error	19-01	Inconsistent AC voltage values	Restart the inverter. If the fault still exists, contact your dealer.
		19-02	Inconsistent BUS voltage values	
		19-03	Inconsistent ISO voltage values	
		19-04	Inconsistent PV voltage values	
		19-05	Inconsistent GFCI	
		19-06	Bus voltage sampling error	
		19-07	PV current sampling error	
13	AC voltage error	31-01	One-level under-voltage of AC power	1. If the fault occurs occasionally, it may be caused by momentary abnormality of the power grid. The inverter will resume normal operation when the power grid gets back to normal. 2. If the fault occurs frequently, check whether the power grid is connected properly.
		31-02	One level over-voltage of AC power	
		31-03	No AC voltage	
		31-04	Two-level under-voltage of AC power	1. If the fault occurs occasionally, it may be caused by momentary abnormality of the power grid. The inverter will resume normal operation when the power grid gets back to normal. 2. If the fault occurs frequently, check whether the power grid is connected properly.
		31-05	Two-level over-voltage of AC power	
		31-06	Startup under-voltage of AC power	
		31-07	Startup over-voltage of AC power	
		31-08	Transient over-voltage of interrupt	
		31-09	Islanding over-voltage	

No.	Fault Type	Fault Code	Fault Description	Actions
		31-10	Oscillation of grid voltage	
14	AC frequency error	33-01	One-level under-frequency of AC power	<p>1. If the fault occurs occasionally, it may be caused by momentary abnormality of the power grid. The inverter will resume normal operation when the power grid gets back to normal.</p> <p>2. If the fault occurs frequently, check whether the power grid is connected properly.</p>
		33-02	One level over-frequency of AC power	
		33-03	Two-level under-frequency of AC power	
		33-04	Two-level over-frequency of AC power	
		33-05	Startup under-frequency of AC power	
		33-06	Startup over-frequency of AC power	
15	Remote shutdown	37-01	Remote shutdown instruction	Check whether any one is trying to shut down the inverter remotely.
16	AFCI error	38-01	Failure of PV string 1	Please turn off the inverter and open the input and output switches, and turn on the inverter again 5 minutes later. If the fault still exists, contact your dealer.
		38-02	Failure of PV string 2	
17	Power-on self-test error of AFCI	39-01	Power-on self-test error of PV string 1	Please turn off the inverter and open the input and output switches, and turn on the inverter again 5 minutes later. If the fault still exists, contact your dealer.
		39-02	Power-on self-test error of PV string 2	
18	AutoTest failure	41-01	AutoTest failure	Please turn off the inverter and open the input and output switches, and turn on the inverter again 5 minutes later. If the fault still exists, contact your dealer.
19	N-PE fault	42-01	N-PE voltage error	Check whether the AC wires are connected properly and reliably to the inverter.
20	Power-on self-test error of leakage current	43-01	Leakage current sensor failure	Please turn off the inverter and open the input and output switches, and turn on the inverter again 5 minutes later. If the fault still exists, contact your dealer.
21	PV string detection error	44-01	PV string failure	Please turn off the inverter and open the input and output switches, and turn on the inverter again 5 minutes later. If the fault still exists, contact your dealer.

No.	Fault Type	Fault Code	Fault Description	Actions
22	Auxiliary power error	45-01	Auxiliary power failure	Please turn off the inverter and open the input and output switches, and turn on the inverter again 5 minutes later. If the fault still exists, contact your dealer.
23	Short circuit of EPS	46-01	Short circuit of EPS	Check whether the correct wire is connected properly to the EPS port.
24	Parallel fault	40-1	Multiple host failure	Please check the master slave settings
		40-2	Parallel CAN communication failure	Please check the parallel CAN wiring
		40-3	Host loss fault	1. Please check the parallel CAN wiring 2. Please check the master slave settings
		40-4	Synchronous zero crossing fault	1. Please check the parallel CAN wiring 2. Please check the master slave settings

Table 10-2 Warning Codes of Inverter

No.	Fault Type	Fault Code	Fault Description	Displayed Information
1	Low fan speed	01-07	Internal fan 1	Please turn off the inverter and open the input and output switches, and turn on the inverter again 5 minutes later. If the fault still exists, contact your dealer.
2	Communication of anti-reflux meter	04-01	Meter failure	Check whether the smart meter is connected properly and supplies power normally.
		04-08	Communication error of meter	Check whether the smart meter is connected properly and supplies power normally.
		04-16	CT cable error	Check whether the CT cable is connected properly.
3	Out-of-range grid voltage	05-00	Out-of-range grid voltage	<p>1. If the fault occurs occasionally, it may be caused by momentary abnormality of the power grid. The inverter will resume normal operation when the power grid gets back to normal.</p> <p>2. If the fault occurs frequently, check whether the power grid is connected properly.</p>
4	Short circuit of PV	06-01	Short circuit of PV2	Check whether the PV input is normal and whether the circuit is short.
		06-02	Short circuit of PV1	
5	Overload	07-01	EPS overload	Reduce the load at the EPS port.
6	Full battery	46-01	Full battery	The battery is fully charged.
7	Low battery voltage	47-01	The battery needs to be charged.	Please charge the battery soon.
		47-02	The battery can only be charged.	Check the priority mode settings and charge the battery.
8	EPS overload alarm	07-01	EPS power exceeds 1.5 times	Please reduce the EPS end load power
		07-02	EPS power exceeds 1.2 times	
		07-03	EPS power exceeds 1.1 times	
		07-04	EPS current exceeds 1.5 times	
		07-05	EPS current exceeds 1.2 times	
		07-06	EPS current exceeds 1.1 times	

## Chapter 11 Product Specifications

	XD3KTL	XD3K6TL	XD4KTL	XD4K6TL	XD5KTL	XD6KTL
<b>Battery Parameters</b>						
Battery type	Lithium battery or lead-acid battery					
Battery voltage (V)	40-60	40-60	40-60	40-60	40-60	40-60
Maximum charge and discharge current (A)	100	100	100	100	100	100
Communication mode	CAN	CAN	CAN	CAN	CAN	CAN
<b>DC input</b>						
Maximum input power (W)	4500	5400	6000	6900	7500	9000
Maximum input voltage (V)	600	600	600	600	600	600
Start-up voltage (V)	100	100	100	100	100	100
Rated voltage (V)	240	240	270	300	330	360
MPPT voltage (V)	100-550	100-550	100-550	100-550	100-550	100-550
MPPT channels	2	2	2	2	2	2
Maximum input current (A)	16	16	16	16	16	16
Maximum input short-circuit current (A)	20	20	20	20	20	20
<b>AC output</b>						
Rated output power (VA)	3000	3680	4000	4600	5000	6000
Maximum output power (VA)	3300	3680	4400	4600	5500	6000
Maximum output current (A)	15	16	20	20.9	22.7	30
Rated voltage (V)	230	230	230	230	230	230
Rated frequency (Hz)	50	50	50	50	50	50
Total harmonic distortion of current (@ rated power)	<3%	<3%	<3%	<3%	<3%	<3%
Power factor	0.8 lead ~ 0.8 lag					
<b>EPS output</b>						
Maximum output power (VA)	3000	3680	4000	4600	5000	6000
Maximum output current (A)	15	16	20	20.9	22.7	30
Peak output power, time (KW, s)	4.5,10	5.4,10	6,10	6.9,10	7.5,10	9,10
Rated output voltage, frequency (V, Hz)	230, 50	230, 50	230, 50	230, 50	230, 50	230, 50
THDv (@ rated power)	<3%	<3%	<3%	<3%	<3%	<3%
Switching time (ms)	<10	<10	<10	<10	<10	<10
<b>Efficiency</b>						

Maximum efficiency	>97.5%	>97.5%	>97.5%	>97.5%	>97.5%	>97.5%
European efficiency	>97.2%	>97.2%	>97.2%	>97.2%	>97.2%	>97.2%
Charge-discharge efficiency	>95%	>95%	>95%	>95%	>95%	>95%
<b>Protection</b>						
Anti-reverse / insulation impedance / grounding protection	Available	Available	Available	Available	Available	Available
Over-current & over-voltage protection	Available	Available	Available	Available	Available	Available
Battery soft start protection	Available	Available	Available	Available	Available	Available
AFCI protection	Optional	Optional	Optional	Optional	Optional	Optional
Lightning protection	Level II	Level II	Level II	Level II	Level II	Level II
<b>General Specifications</b>						
Ambient temperature	-30°C~+60°C					
Standby power (W)	<10	<10	<10	<10	<10	<10
Topology	High-frequency isolation (for battery)					
Ingress protection	IP66	IP66	IP66	IP66	IP66	IP66
RH	0~100%	0~100%	0~100%	0~100%	0~100%	0~100%
Communication	RS485 & CAN & Wi-Fi & 4G & LAN & Bluetooth					
Maximum working altitude (m)	4000	4000	4000	4000	4000	4000
Noise	≤25dB	≤25dB	≤25dB	≤25dB	≤25dB	≤25dB
Cooling mode	Natural cooling					
Display	LCD	LCD	LCD	LCD	LCD	LCD
Dimension	490*395*200	490*395*200	490*395*200	490*395*200	490*395*200	490*395*200
Weight	21.35Kg	21.35Kg	21.35Kg	21.35Kg	21.35Kg	21.35Kg





Hotline: +86 400 700 9997    E-mail: [solar-service@invt.com.cn](mailto:solar-service@invt.com.cn)    Website: [www.invt-solar.com](http://www.invt-solar.com)

INVT Solar Technology (Shenzhen) Co., Ltd.

2th Floor, Block B, INVT Light Technology Building, Songbai Road, Matian, Guangming District, Shenzhen, China

This Manual is subject to change without prior notice due to product improvements. All rights reserved. Reproduction is prohibited without prior written permission.

202310 (V1.0)